

# SERVICE MANUAL



## MULTI-SPLIT SYSTEM NORDIC MULTI LIGHT Series Outdoor units

CHML-U14RK2-NG  
CHML-U18RK2-NG  
CHML-U21RK3-NG  
CHML-U24RK3-NG  
CHML-U28RK4-NG  
CHML-U36RK4-NG  
CHML-U42RK5-NG

For proper operation, please read and keep this manual carefully.  
Designed by Cooper&Hunter International Corporation, FL Miami, USA

[www.cooperandhunter.com](http://www.cooperandhunter.com)





# 1. Summary

## Outdoor Unit:

CHML-U14RK2-NG  
CHML-U18RK2-NG



CHML-U21RK3-NG  
CHML-U24RK3-NG  
CHML-U28RK4-NG

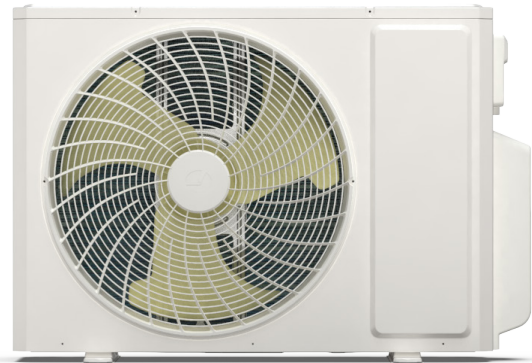

CHML-U36RK4-NG  
CHML-U42RK5-NG

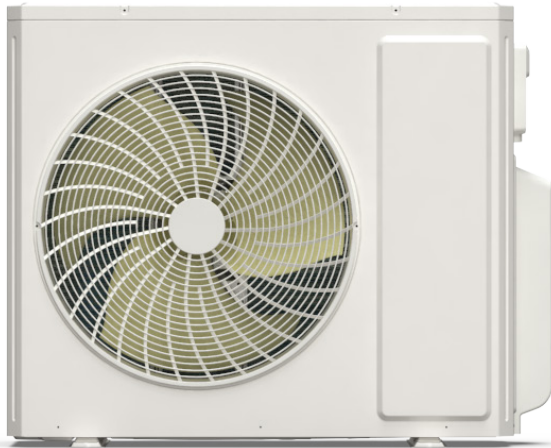

## 2. Specifications

Model	-	CHML-U14RK2-NG
Product Code	-	
Rated Voltage	V~	220-240
Rated Frequency	Hz	50
Phases	-	1
Cooling Capacity	kW	4.1
Heating Capacity	kW	4.4
Cooling Power Input	kW	1.1
Heating Power Input	kW	0.97
Cooling Current Input	A	4.88
Heating Current Input	A	4.44
Rated Power Input	kW	2.25
Rated Current	A	10
EER	W/W	3.73
COP	W/W	4.54
SEER	-	7.20
SCOP	-	4.20
Compressor Trademark	-	ZHUHAI LANDA COMPRESSOR CO.,LTD
Compressor Model	-	QXF-A120zH170A
Compressor Refrigerant Oil Type	-	FW68DA
Compressor Type	-	Inverter Rotary
L.R.A	A	25
Compressor Rated Load Amp (RLA)	A	/
Compressor Power Input	W	1096
Compressor Thermal Protector	-	KSD115°C HPC115/95U1
Throttling Method	-	Electron expansion valve
Cooling Operation Ambient Temperature Range	°C	-15~43
Heating Operation Ambient Temperature Range	°C	-22~24
Condenser Material	-	Aluminum Fin-copper Tube
Condenser Pipe Diameter	mm	Φ7.94
Rows-Fin Gap(mm)	mm	1-1.2
Coil length (L) X Height (H) X Coil width (W)	mm	834×528×19.05
Fan Motor Speed (rpm) (H/M/L)	rpm	Cooling: 800 / Heating: 860
Output of Fan Motor	W	30
Fan Motor RLA	A	0.4
Fan Motor Capacitor	μF	/
Air Flow Volume of Outdoor Unit	m <sup>3</sup> /h	2300
Fan Type-Piece	-	Axial-flow
Fan Diameter-Height	mm	Φ420-131.1
Defrosting Method	-	Automatic Defrosting
Climate Type	-	T1
Isolation	-	I
Moisture Protection	-	IPX4
Permissible Excessive Operating Pressure for the Discharge Side	MPa	4.3
Permissible Excessive Operating Pressure for the Suction Side	MPa	2.5
Dimension (W×D×H)	mm	822×352×550
Dimension of Carton Box (L×W×H)	mm	869×395×594
Dimension of Package (L×W×H)	mm	872×398×620
Net Weight	kg	30
Gross Weight	kg	32.5

## 2. Specifications

Refrigerant	-	R32
Refrigerant Charge	kg	0.75
Cross-sectional Area of Power Cable Conductor	mm <sup>2</sup>	1.5
Recommended Power Cable(Core)	N	3
Connection Pipe Connection Method	-	Flare Connection
Not Additional Gas Connection Pipe Length	m	10
Connection Pipe Gas Additional Charge	g/m	20
Outer Diameter of Liquid Pipe1	inch	1/4
Outer Diameter of Gas Pipe1	inch	3/8
Outer Diameter of Liquid Pipe2	inch	1/4
Outer Diameter of Gas Pipe2	inch	3/8
Outer Diameter of Liquid Pipe3	inch	/
Outer Diameter of Gas Pipe3	inch	/
Outer Diameter of Liquid Pipe4	inch	/
Outer Diameter of Gas Pipe4	inch	/
Outer Diameter of Liquid Pipe5	inch	/
Outer Diameter of Gas Pipe5	inch	/
Connection Pipe Max. Height Distance (Indoor and Indoor)	m	15
Max. equivalent connection pipe length	m	20
Connection Pipe Max. Length Distance (total length)	m	40

The above data is subject to change without notice; please refer to the nameplate of the unit.

## 2. Specifications

Model	-	CHML-U18RK2-NG
Product Code	-	
Rated Voltage	V~	220-240
Rated Frequency	Hz	50
Phases	-	1
Cooling Capacity	kW	5.3
Heating Capacity	kW	5.65
Cooling Power Input	kW	1.48
Heating Power Input	kW	1.25
Cooling Current Input	A	6.56
Heating Current Input	A	5.55
Rated Power Input	kW	2.5
Rated Current	A	11
EER	W/W	3.58
COP	W/W	4.52
SEER	-	7.20
SCOP	-	4.20
Compressor Trademark	-	ZHUHAI LANDA COMPRESSOR CO.,LTD
Compressor Model	-	QXF-A139zH170A
Compressor Refrigerant Oil Type	-	FW68DA
Compressor Type	-	Inverter Rotary
L.R.A	A	25
Compressor Rated Load Amp (RLA)	A	/
Compressor Power Input	W	1295
Compressor Thermal Protector	-	KSD115°C HPC115/95U1
Throttling Method	-	Electron expansion valve
Cooling Operation Ambient Temperature Range	°C	-15~43
Heating Operation Ambient Temperature Range	°C	-22~24
Condenser Material	-	Aluminum Fin-copper Tube
Condenser Pipe Diameter	mm	Φ7
Rows-Fin Gap(mm)	mm	2-1.4
Coil length (L) X Height (H) X Coil width (W)	mm	834×528×38.1
Fan Motor Speed (rpm) (H/M/L)	rpm	Cooling: 800 / Heating: 860
Output of Fan Motor	W	30
Fan Motor RLA	A	0.4
Fan Motor Capacitor	μF	/
Air Flow Volume of Outdoor Unit	m <sup>3</sup> /h	2300
Fan Type-Piece	-	Axial-flow
Fan Diameter-Height	mm	Φ420-131.1
Defrosting Method	-	Automatic Defrosting
Climate Type	-	T1
Isolation	-	I
Moisture Protection	-	IPX4
Permissible Excessive Operating Pressure for the Discharge Side	MPa	4.3
Permissible Excessive Operating Pressure for the Suction Side	MPa	2.5
Dimension (W×D×H)	mm	822×352×550
Dimension of Carton Box (L×W×H)	mm	869×395×594
Dimension of Package (L×W×H)	mm	872×398×620
Net Weight	kg	32
Gross Weight	kg	34.5

## 2. Specifications

Refrigerant	-	R32
Refrigerant Charge	kg	0.9
Cross-sectional Area of Power Cable Conductor	mm <sup>2</sup>	1.5
Recommended Power Cable(Core)	N	3
Connection Pipe Connection Method	-	Flare Connection
Not Additional Gas Connection Pipe Length	m	10
Connection Pipe Gas Additional Charge	g/m	20
Outer Diameter of Liquid Pipe1	inch	1/4
Outer Diameter of Gas Pipe1	inch	3/8
Outer Diameter of Liquid Pipe2	inch	1/4
Outer Diameter of Gas Pipe2	inch	3/8
Outer Diameter of Liquid Pipe3	inch	/
Outer Diameter of Gas Pipe3	inch	/
Outer Diameter of Liquid Pipe4	inch	/
Outer Diameter of Gas Pipe4	inch	/
Outer Diameter of Liquid Pipe5	inch	/
Outer Diameter of Gas Pipe5	inch	/
Connection Pipe Max. Height Distance (Indoor and Indoor)	m	15
Max. equivalent connection pipe length	m	20
Connection Pipe Max. Length Distance (total length)	m	40

The above data is subject to change without notice; please refer to the nameplate of the unit.

## 2. Specifications

Model	-	CHML-U21RK3-NG
Product Code	-	
Rated Voltage	V~	220-240
Rated Frequency	Hz	50
Phases	-	1
Cooling Capacity	kW	6.1
Heating Capacity	kW	6.5
Cooling Power Input	kW	1.48
Heating Power Input	kW	1.43
Cooling Current Input	A	6.57
Heating Current Input	A	6.34
Rated Power Input	kW	2.9
Rated Current	A	12.9
EER	W/W	4.12
COP	W/W	4.55
SEER	-	7.80
SCOP	-	4.30
Compressor Trademark	-	ZHUHAI LANDA COMPRESSOR CO., LTD.
Compressor Model	-	FTz-SM151AXB
Compressor Refrigerant Oil Type	-	FW68DA or equivalent
Compressor Type	-	Twin Rotary
L.R.A	A	18
Compressor Rated Load Amp (RLA)	A	/
Compressor Power Input	W	1330
Compressor Thermal Protector	-	KSD115°C HPC115/95U1
Throttling Method	-	Electron expansion valve
Cooling Operation Ambient Temperature Range	°C	-15~43
Heating Operation Ambient Temperature Range	°C	-22~24
Condenser Material	-	Aluminum Fin-copper Tube
Condenser Pipe Diameter	mm	Φ7
Rows-Fin Gap(mm)	mm	2-1.4
Coil length (L) X Height (H) X Coil width (W)	mm	851×616×38.1
Fan Motor Speed (rpm) (H/M/L)	rpm	Cooling: 850 / Heating: 800
Output of Fan Motor	W	60
Fan Motor RLA	A	0.426
Fan Motor Capacitor	μF	/
Air Flow Volume of Outdoor Unit	m <sup>3</sup> /h	3800
Fan Type-Piece	-	Axial-flow
Fan Diameter-Height	mm	Φ520-154
Defrosting Method	-	Automatic Defrosting
Climate Type	-	T1
Isolation	-	I
Moisture Protection	-	IPX4
Permissible Excessive Operating Pressure for the Discharge Side	MPa	4.3
Permissible Excessive Operating Pressure for the Suction Side	MPa	2.5
Dimension (WXDXH)	mm	964×402×660
Dimension of Carton Box (LXWXH)	mm	1029×453×715
Dimension of Package (LXWXH)	mm	1032×456×737
Net Weight	kg	47.5
Gross Weight	kg	52

## 2. Specifications

Refrigerant	-	R32
Refrigerant Charge	kg	1.6
Cross-sectional Area of Power Cable Conductor	mm <sup>2</sup>	2.5
Recommended Power Cable(Core)	N	3
Connection Pipe Connection Method	-	Flare Connection
Not Additional Gas Connection Pipe Length	m	30
Connection Pipe Gas Additional Charge	g/m	20
Outer Diameter of Liquid Pipe1	inch	1/4
Outer Diameter of Gas Pipe1	inch	3/8
Outer Diameter of Liquid Pipe2	inch	1/4
Outer Diameter of Gas Pipe2	inch	3/8
Outer Diameter of Liquid Pipe3	inch	1/4
Outer Diameter of Gas Pipe3	inch	3/8
Outer Diameter of Liquid Pipe4	inch	/
Outer Diameter of Gas Pipe4	inch	/
Outer Diameter of Liquid Pipe5	inch	/
Outer Diameter of Gas Pipe5	inch	/
Connection Pipe Max. Height Distance (Indoor and Indoor)	m	15
Max. equivalent connection pipe length	m	20
Connection Pipe Max. Length Distance (total length)	m	60

The above data is subject to change without notice; please refer to the nameplate of the unit.

## 2. Specifications

Model	-	CHML-U24RK3-NG
Product Code	-	
Rated Voltage	V~	220-240
Rated Frequency	Hz	50
Phases	-	1
Cooling Capacity	kW	7.1
Heating Capacity	kW	8.6
Cooling Power Input	kW	1.88
Heating Power Input	kW	2.23
Cooling Current Input	A	8.34
Heating Current Input	A	9.89
Rated Power Input	kW	Cooling: 3.4 / Heating: 3.0
Rated Current	A	Cooling: 15 / Heating: 14.6
EER	W/W	3.78
COP	W/W	3.86
SEER	-	7.10
SCOP	-	4.30
Compressor Trademark	-	ZHUHAI LANDA COMPRESSOR CO., LTD.
Compressor Model	-	QXFS-M180zX170
Compressor Refrigerant Oil Type	-	FW68DA or equivalent
Compressor Type	-	Twin Rotary
L.R.A	A	24
Compressor Rated Load Amp (RLA)	A	/
Compressor Power Input	W	1480
Compressor Thermal Protector	-	HPC115/95/KSD115°C
Throttling Method	-	Electron expansion valve
Cooling Operation Ambient Temperature Range	°C	-15~43
Heating Operation Ambient Temperature Range	°C	-22~24
Condenser Material	-	Aluminum Fin-copper Tube
Condenser Pipe Diameter	mm	Φ7
Rows-Fin Gap(mm)	mm	2-1.4
Coil length (L) X Height (H) X Coil width (W)	mm	851×616×38.1
Fan Motor Speed (rpm) (H/M/L)	rpm	Cooling: 850 / Heating: 800
Output of Fan Motor	W	60
Fan Motor RLA	A	0.426
Fan Motor Capacitor	μF	/
Air Flow Volume of Outdoor Unit	m <sup>3</sup> /h	3800
Fan Type-Piece	-	Axial-flow
Fan Diameter-Height	mm	Φ520-154
Defrosting Method	-	Automatic Defrosting
Climate Type	-	T1
Isolation	-	I
Moisture Protection	-	IPX4
Permissible Excessive Operating Pressure for the Discharge Side	MPa	4.3
Permissible Excessive Operating Pressure for the Suction Side	MPa	2.5
Dimension (W×D×H)	mm	964×402×660
Dimension of Carton Box (L×W×H)	mm	1029×453×715
Dimension of Package (L×W×H)	mm	1032×456×737
Net Weight	kg	47.5
Gross Weight	kg	52



## 2. Specifications

Refrigerant	-	R32
Refrigerant Charge	kg	1.7
Cross-sectional Area of Power Cable Conductor	mm <sup>2</sup>	2.5
Recommended Power Cable(Core)	N	3
Connection Pipe Connection Method	-	Flare Connection
Not Additional Gas Connection Pipe Length	m	30
Connection Pipe Gas Additional Charge	g/m	20
Outer Diameter of Liquid Pipe1	inch	1/4
Outer Diameter of Gas Pipe1	inch	3/8
Outer Diameter of Liquid Pipe2	inch	1/4
Outer Diameter of Gas Pipe2	inch	3/8
Outer Diameter of Liquid Pipe3	inch	1/4
Outer Diameter of Gas Pipe3	inch	3/8
Outer Diameter of Liquid Pipe4	inch	/
Outer Diameter of Gas Pipe4	inch	/
Outer Diameter of Liquid Pipe5	inch	/
Outer Diameter of Gas Pipe5	inch	/
Connection Pipe Max. Height Distance (Indoor and Indoor)	m	15
Max. equivalent connection pipe length	m	20
Connection Pipe Max. Length Distance (total length)	m	60

The above data is subject to change without notice; please refer to the nameplate of the unit.

## 2. Specifications

Model	-	CHML-U28RK4-NG
Product Code	-	
Rated Voltage	V~	220-240
Rated Frequency	Hz	50
Phases	-	1
Cooling Capacity	kW	8
Heating Capacity	kW	9.5
Cooling Power Input	kW	2.12
Heating Power Input	kW	2.2
Cooling Current Input	A	9.41
Heating Current Input	A	9.76
Rated Power Input	kW	3.6
Rated Current	A	15.97
EER	W/W	3.77
COP	W/W	4.32
SEER	-	7.20
SCOP	-	4.20
Compressor Trademark	-	ZHUHAI LANDA COMPRESSOR CO., LTD.
Compressor Model	-	QXFS-B212zX070
Compressor Refrigerant Oil Type	-	FW68DA or equivalent
Compressor Type	-	Twin Rotary
L.R.A	A	35
Compressor Rated Load Amp (RLA)	A	/
Compressor Power Input	W	1887
Compressor Thermal Protector	-	KSD115°C HPC115/95U1
Throttling Method	-	Electron expansion valve
Cooling Operation Ambient Temperature Range	°C	-15~43
Heating Operation Ambient Temperature Range	°C	-22~24
Condenser Material	-	Aluminum Fin-copper Tube
Condenser Pipe Diameter	mm	Φ7.94
Rows-Fin Gap(mm)	mm	2-1.4
Coil length (L) X Height (H) X Coil width (W)	mm	851×616×38.1
Fan Motor Speed (rpm) (H/M/L)	rpm	Cooling: 850 / Heating: 800
Output of Fan Motor	W	60
Fan Motor RLA	A	0.426
Fan Motor Capacitor	μF	/
Air Flow Volume of Outdoor Unit	m <sup>3</sup> /h	3800
Fan Type-Piece	-	Axial-flow
Fan Diameter-Height	mm	Φ520-154
Defrosting Method	-	Automatic Defrosting
Climate Type	-	T1
Isolation	-	I
Moisture Protection	-	IPX4
Permissible Excessive Operating Pressure for the Discharge Side	MPa	4.3
Permissible Excessive Operating Pressure for the Suction Side	MPa	2.5
Dimension (W×D×H)	mm	964×402×660
Dimension of Carton Box (L×W×H)	mm	1029×453×715
Dimension of Package (L×W×H)	mm	1032×456×737
Net Weight	kg	51
Gross Weight	kg	55.5

## 2. Specifications

Refrigerant	-	R32
Refrigerant Charge	kg	1.8
Cross-sectional Area of Power Cable Conductor	mm <sup>2</sup>	2.5
Recommended Power Cable(Core)	N	3
Connection Pipe Connection Method	-	Flare Connection
Not Additional Gas Connection Pipe Length	m	40
Connection Pipe Gas Additional Charge	g/m	20
Outer Diameter of Liquid Pipe1	inch	1/4
Outer Diameter of Gas Pipe1	inch	3/8
Outer Diameter of Liquid Pipe2	inch	1/4
Outer Diameter of Gas Pipe2	inch	3/8
Outer Diameter of Liquid Pipe3	inch	1/4
Outer Diameter of Gas Pipe3	inch	3/8
Outer Diameter of Liquid Pipe4	inch	1/4
Outer Diameter of Gas Pipe4	inch	3/8
Outer Diameter of Liquid Pipe5	inch	/
Outer Diameter of Gas Pipe5	inch	/
Connection Pipe Max. Height Distance (Indoor and Indoor)	m	15
Max. equivalent connection pipe length	m	20
Connection Pipe Max. Length Distance (total length)	m	70

The above data is subject to change without notice; please refer to the nameplate of the unit.

## 2. Specifications

Model	-	CHML-U36RK4-NG
Product Code	-	
Rated Voltage	V~	220-240
Rated Frequency	Hz	50
Phases	-	1
Cooling Capacity	kW	10.6
Heating Capacity	kW	12
Cooling Power Input	kW	3
Heating Power Input	kW	3.04
Cooling Current Input	A	13.31
Heating Current Input	A	13.49
Rated Power Input	kW	Cooling: 4.6 / Heating: 5.0
Rated Current	A	Cooling: 20.41 / Heating: 21.74
EER	W/W	3.53
COP	W/W	3.95
SEER	-	7.20
SCOP	-	4.00
Compressor Trademark	-	ZHUHAI LANDA COMPRESSOR CO., LTD.
Compressor Model	-	QXFS-D280zX070C
Compressor Refrigerant Oil Type	-	FW68DA or equivalent
Compressor Type	-	Twin Rotary
L.R.A	A	40
Compressor Rated Load Amp (RLA)	A	/
Compressor Power Input	W	2294
Compressor Thermal Protector	-	KSD115°C HPC115/95U1
Throttling Method	-	Electron expansion valve
Cooling Operation Ambient Temperature Range	°C	-15~43
Heating Operation Ambient Temperature Range	°C	-22~24
Condenser Material	-	Aluminum Fin-copper Tube
Condenser Pipe Diameter	mm	Φ7.94
Rows-Fin Gap(mm)	mm	2-1.4
Coil length (L) X Height (H) X Coil width (W)	mm	1066×792×38.1
Fan Motor Speed (rpm) (H/M/L)	rpm	Cooling: 800 / Heating: 860
Output of Fan Motor	W	130
Fan Motor RLA	A	/
Fan Motor Capacitor	μF	/
Air Flow Volume of Outdoor Unit	m <sup>3</sup> /h	5800
Fan Type-Piece	-	Axial-flow
Fan Diameter-Height	mm	Φ550-205
Defrosting Method	-	Automatic Defrosting
Climate Type	-	T1
Isolation	-	I
Moisture Protection	-	IPX4
Permissible Excessive Operating Pressure for the Discharge Side	MPa	4.3
Permissible Excessive Operating Pressure for the Suction Side	MPa	2.5
Dimension (W×D×H)	mm	1020×427×826
Dimension of Carton Box (L×W×H)	mm	1090×494×870
Dimension of Package (L×W×H)	mm	1093×497×885
Net Weight	kg	72
Gross Weight	kg	79

## 2. Specifications

Refrigerant	-	R32
Refrigerant Charge	kg	2.4
Cross-sectional Area of Power Cable Conductor	mm <sup>2</sup>	4
Recommended Power Cable(Core)	N	3
Connection Pipe Connection Method	-	Flare Connection
Not Additional Gas Connection Pipe Length	m	40
Connection Pipe Gas Additional Charge	g/m	20
Outer Diameter of Liquid Pipe1	inch	1/4
Outer Diameter of Gas Pipe1	inch	3/8
Outer Diameter of Liquid Pipe2	inch	1/4
Outer Diameter of Gas Pipe2	inch	3/8
Outer Diameter of Liquid Pipe3	inch	1/4
Outer Diameter of Gas Pipe3	inch	3/8
Outer Diameter of Liquid Pipe4	inch	1/4
Outer Diameter of Gas Pipe4	inch	3/8
Outer Diameter of Liquid Pipe5	inch	/
Outer Diameter of Gas Pipe5	inch	/
Connection Pipe Max. Height Distance (Indoor and Indoor)	m	25
Max. equivalent connection pipe length	m	25
Connection Pipe Max. Length Distance (total length)	m	80

The above data is subject to change without notice; please refer to the nameplate of the unit.

## 2. Specifications

Model	-	CHML-U42RK5-NG
Product Code	-	
Rated Voltage	V~	220-240
Rated Frequency	Hz	50
Phases	-	1
Cooling Capacity	kW	12.1
Heating Capacity	kW	13
Cooling Power Input	kW	3.4
Heating Power Input	kW	3.19
Cooling Current Input	A	15.08
Heating Current Input	A	14.15
Rated Power Input	kW	Cooling: 4.6 / Heating: 5.0
Rated Current	A	Cooling: 20.41 / Heating: 21.74
EER	W/W	3.56
COP	W/W	4.08
SEER	-	7.20( $\eta_s, c=289$ )
SCOP	-	4.20( $\eta_s, h=165$ )
Compressor Trademark	-	ZHUHAI LANDA COMPRESSOR CO., LTD.
Compressor Model	-	QXFS-D280zX070C
Compressor Refrigerant Oil Type	-	FW68DA or equivalent
Compressor Type	-	Twin Rotary
L.R.A	A	40
Compressor Rated Load Amp (RLA)	A	/
Compressor Power Input	W	2294
Compressor Thermal Protector	-	KSD115°C HPC115/95U1
Throttling Method	-	Electron expansion valve
Cooling Operation Ambient Temperature Range	°C	-15~43
Heating Operation Ambient Temperature Range	°C	-22~24
Condenser Material	-	Aluminum Fin-copper Tube
Condenser Pipe Diameter	mm	Φ7.94
Rows-Fin Gap(mm)	mm	2-1.4
Coil length (L) X Height (H) X Coil width (W)	mm	1066×792×38.1
Fan Motor Speed (rpm) (H/M/L)	rpm	Cooling: 860 / Heating: 860
Output of Fan Motor	W	130
Fan Motor RLA	A	/
Fan Motor Capacitor	μF	/
Air Flow Volume of Outdoor Unit	m <sup>3</sup> /h	5800
Fan Type-Piece	-	Axial-flow
Fan Diameter-Height	mm	Φ550-205
Defrosting Method	-	Automatic Defrosting
Climate Type	-	T1
Isolation	-	I
Moisture Protection	-	IPX4
Permissible Excessive Operating Pressure for the Discharge Side	MPa	4.3
Permissible Excessive Operating Pressure for the Suction Side	MPa	2.5
Dimension (W×D×H)	mm	1020×427×826
Dimension of Carton Box (L×W×H)	mm	1090×494×870
Dimension of Package (L×W×H)	mm	1093×497×885
Net Weight	kg	73
Gross Weight	kg	80

## 2. Specifications

Refrigerant	-	R32
Refrigerant Charge	kg	2.4
Cross-sectional Area of Power Cable Conductor	mm <sup>2</sup>	4
Recommended Power Cable(Core)	N	3
Connection Pipe Connection Method	-	Flare Connection
Not Additional Gas Connection Pipe Length	m	50
Connection Pipe Gas Additional Charge	g/m	20
Outer Diameter of Liquid Pipe1	inch	1/4
Outer Diameter of Gas Pipe1	inch	3/8
Outer Diameter of Liquid Pipe2	inch	1/4
Outer Diameter of Gas Pipe2	inch	3/8
Outer Diameter of Liquid Pipe3	inch	1/4
Outer Diameter of Gas Pipe3	inch	3/8
Outer Diameter of Liquid Pipe4	inch	1/4
Outer Diameter of Gas Pipe4	inch	3/8
Outer Diameter of Liquid Pipe5	inch	1/4
Outer Diameter of Gas Pipe5	inch	3/8
Connection Pipe Max. Height Distance (Indoor and Indoor)	m	25
Max. equivalent connection pipe length	m	25
Connection Pipe Max. Length Distance (total length)	m	100

The above data is subject to change without notice; please refer to the nameplate of the unit.

# 3. Outline Dimension Diagram

CHML-U14RK2-NG  
CHML-U18RK2-NG

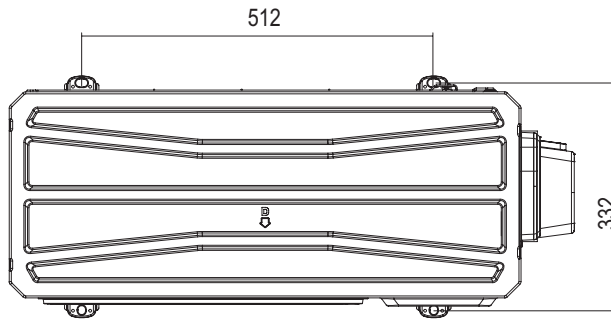
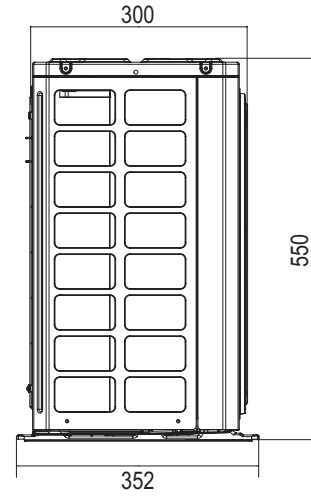
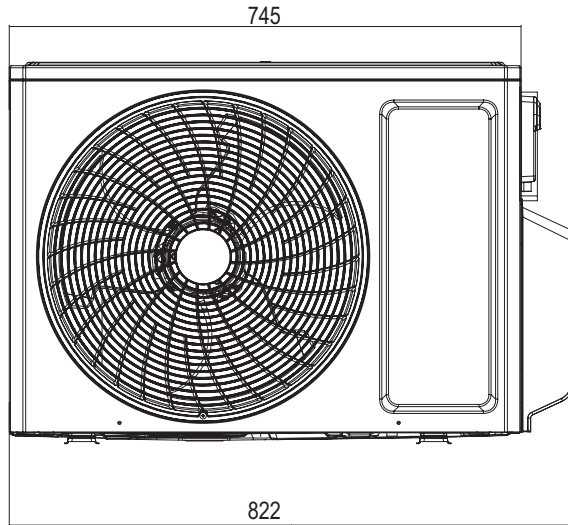

Unit:mm

CHML-U21RK3-NG  
CHML-U24RK3-NG  
CHML-U28RK4-NG

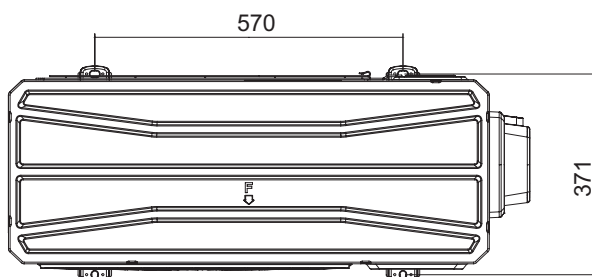
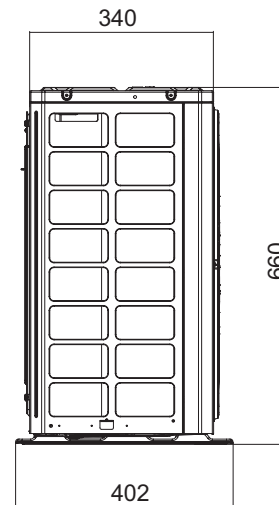
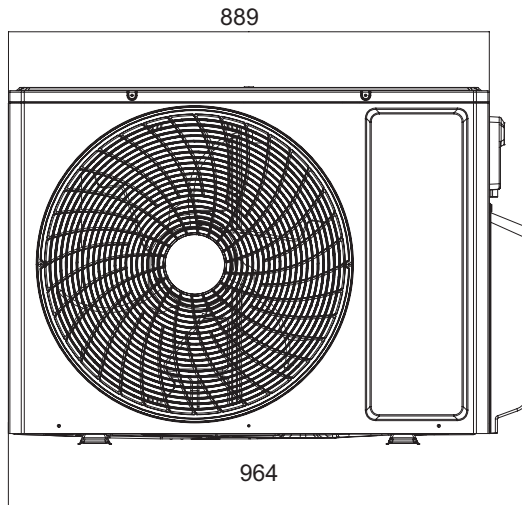

Unit:mm



# 3. Outline Dimension Diagram

CHML-U36RK4-NG  
CHML-U42RK5-NG

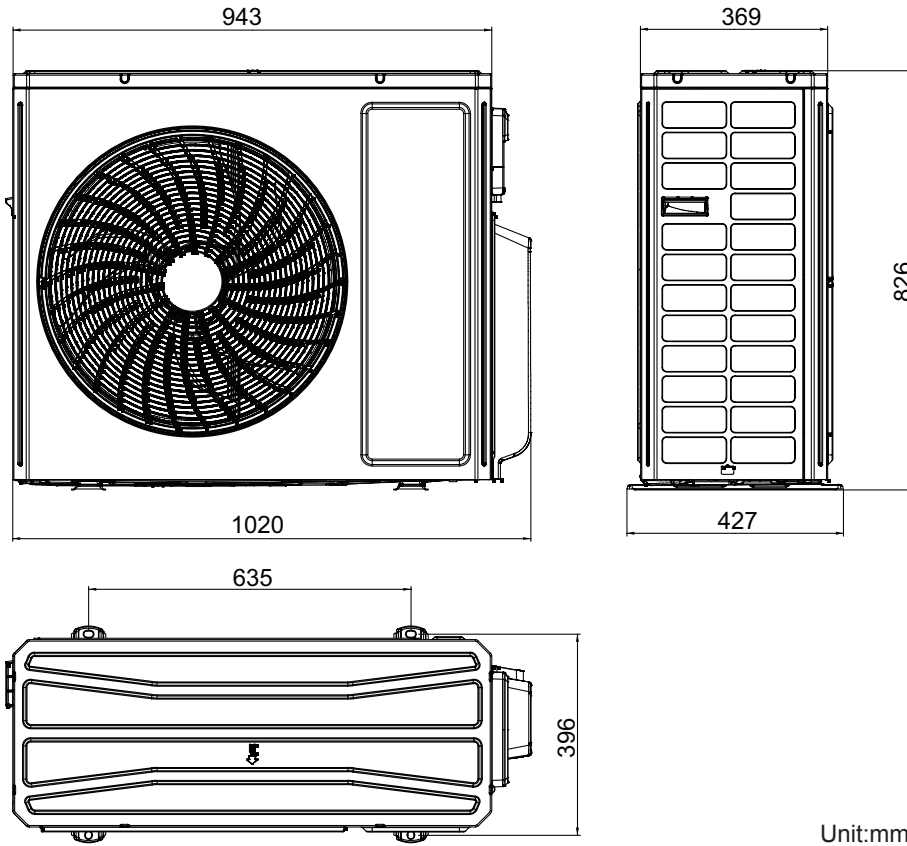

# 4. Refrigerant System Diagram

CHML-U14RK2-NG  
CHML-U18RK2-NG

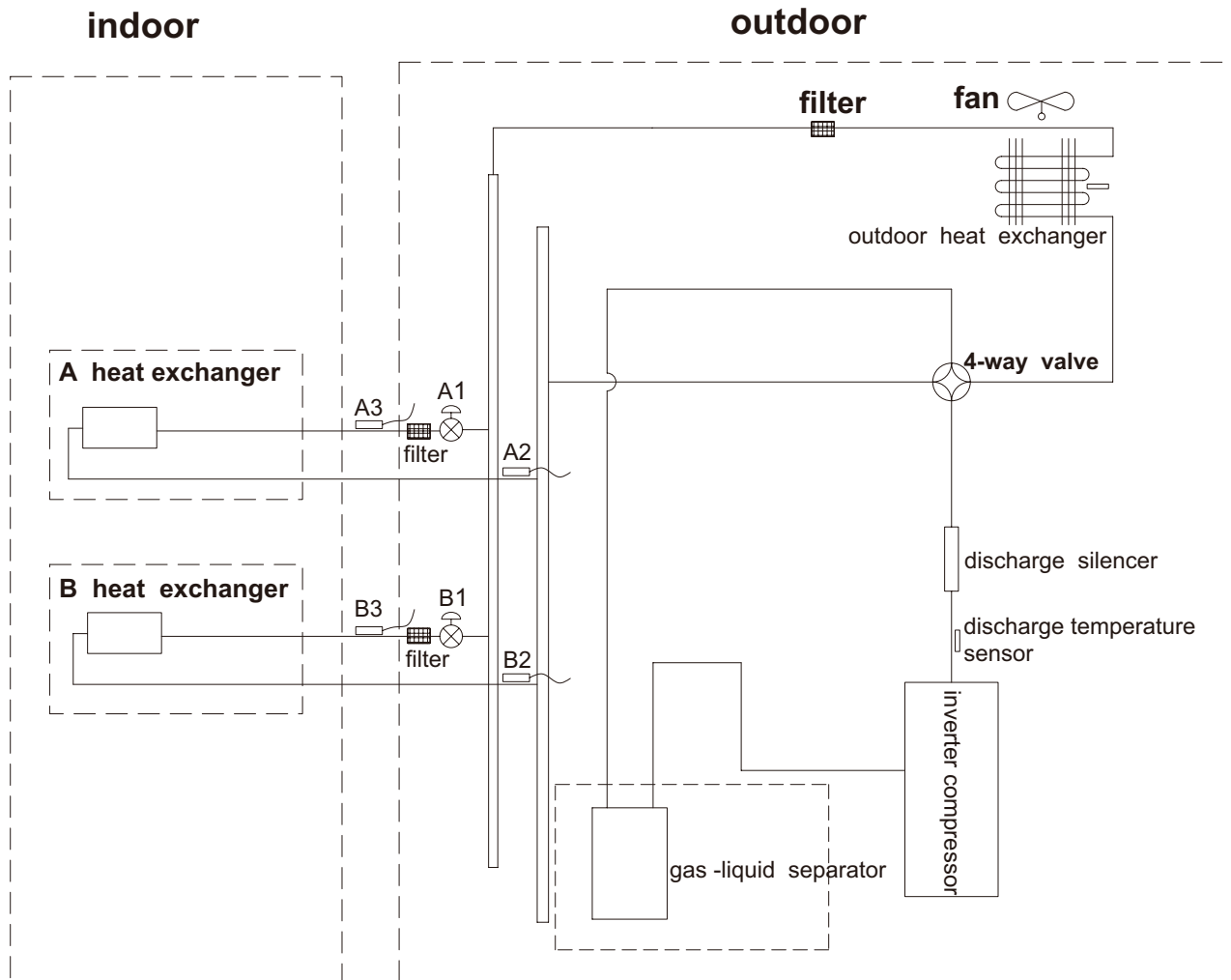

A1: A-unit electronic expansion valve  
B1: B-unit electronic expansion valve

A2: A-unit gas pipe temperature sensor  
B2: B-unit gas pipe temperature sensor

A3: A-unit liquid pipe temperature sensor  
B3: B-unit liquid pipe temperature sensor

# 4. Refrigerant System Diagram

CHML-U21RK3-NG  
CHML-U24RK3-NG

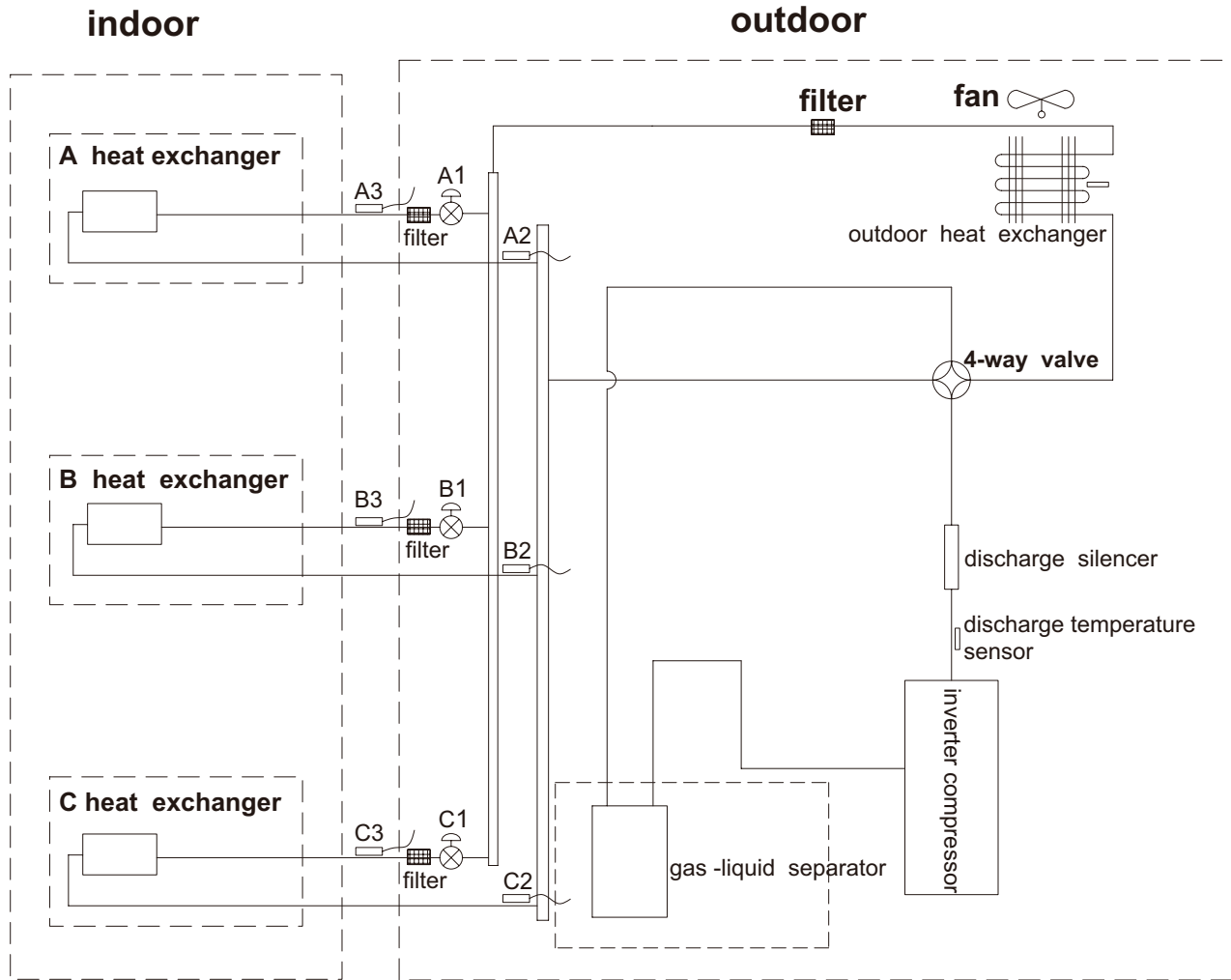

A1: A-unit electronic expansion valve  
B1: B-unit electronic expansion valve  
C1: C-unit electronic expansion valve

A2: A-unit gas pipe temperature sensor  
B2: B-unit gas pipe temperature sensor  
C2: C-unit gas pipe temperature sensor

A3: A-unit liquid pipe temperature sensor  
B3: B-unit liquid pipe temperature sensor  
C3: C-unit liquid pipe temperature sensor

# 4. Refrigerant System Diagram

CHML-U28RK4-NG  
CHML-U36RK4-NG

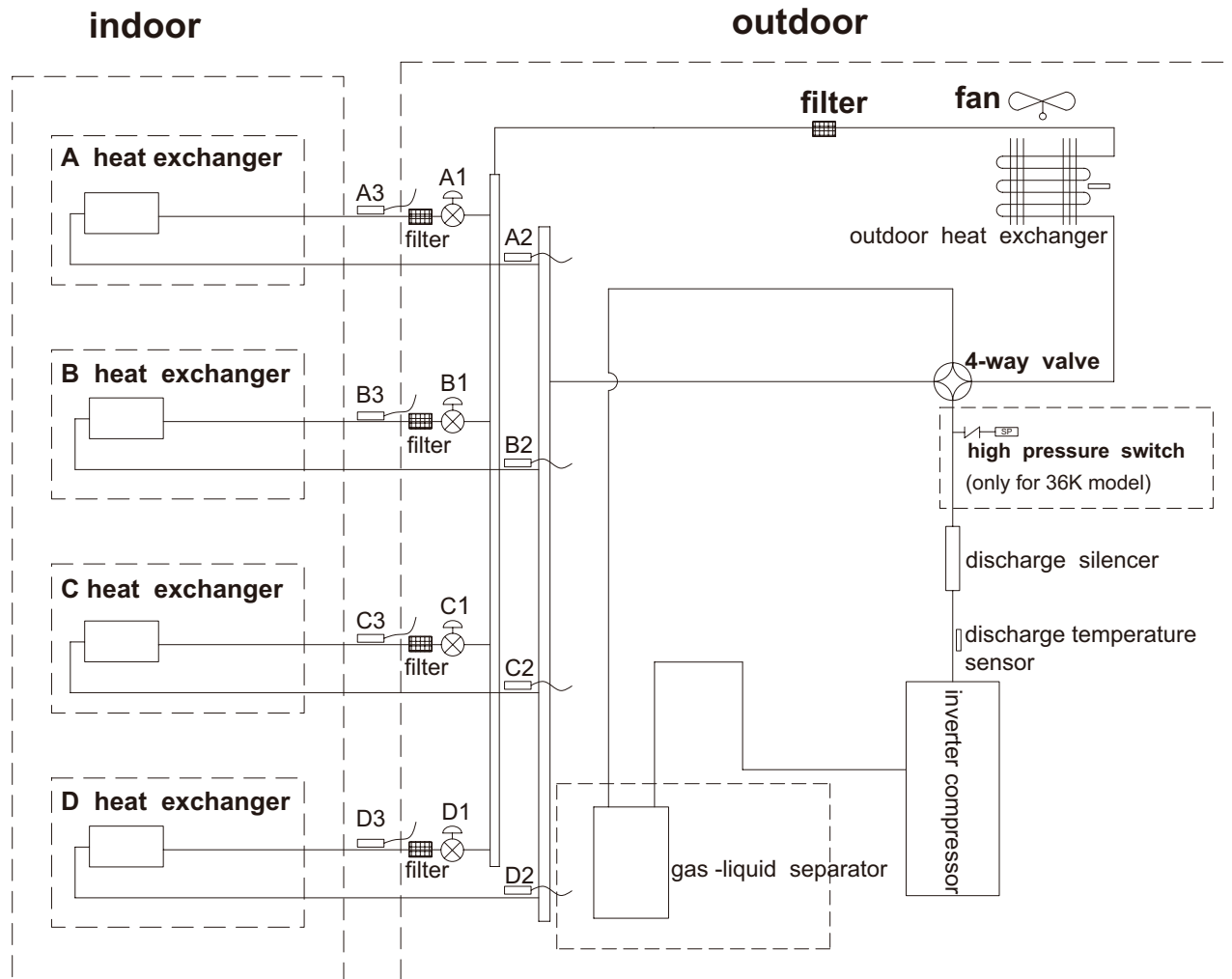

A1: A-unit electronic expansion valve  
B1: B-unit electronic expansion valve  
C1: C-unit electronic expansion valve  
D1: D-unit electronic expansion valve

A2: A-unit gas pipe temperature sensor  
B2: B-unit gas pipe temperature sensor  
C2: C-unit gas pipe temperature sensor  
D2: D-unit gas pipe temperature sensor

A3: A-unit liquid pipe temperature sensor  
B3: B-unit liquid pipe temperature sensor  
C3: C-unit liquid pipe temperature sensor  
D3: D-unit liquid pipe temperature sensor

# 4. Refrigerant System Diagram

CHML-U42RK5-NG

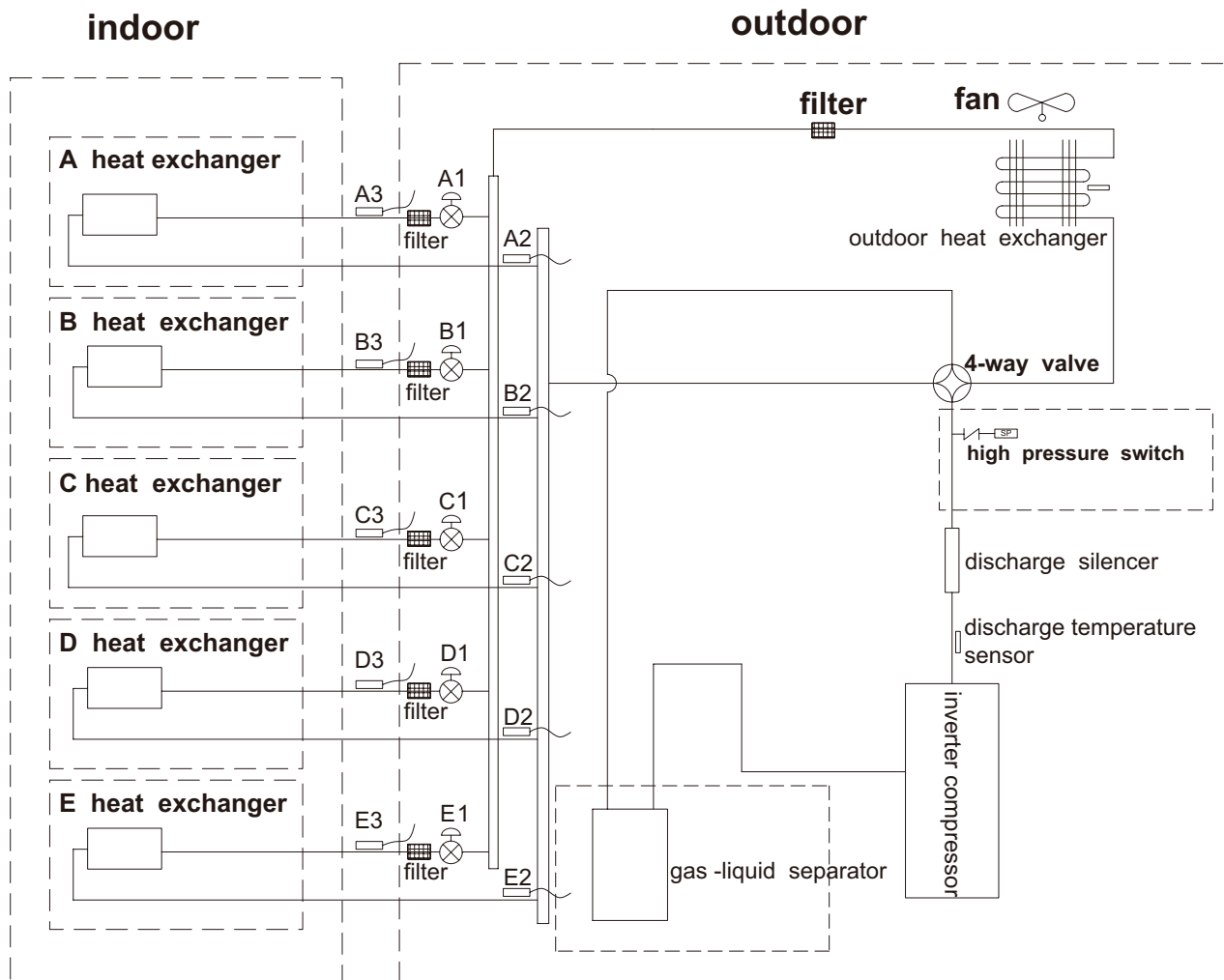

A1: A-unit electronic expansion valve  
 B1: B-unit electronic expansion valve  
 C1: C-unit electronic expansion valve  
 D1: D-unit electronic expansion valve  
 E1: E-unit electronic expansion valve

A2: A-unit gas pipe temperature sensor  
 B2: B-unit gas pipe temperature sensor  
 C2: C-unit gas pipe temperature sensor  
 D2: D-unit gas pipe temperature sensor  
 E2: E-unit gas pipe temperature sensor

A3: A-unit liquid pipe temperature sensor  
 B3: B-unit liquid pipe temperature sensor  
 C3: C-unit liquid pipe temperature sensor  
 D3: D-unit liquid pipe temperature sensor  
 E3: E-unit liquid pipe temperature sensor

# 5. Electrical Part

## 5.1 Wiring Diagram

### • Instruction

Symbol	Symbol Color	Symbol	Symbol Color	Symbol	Name
WH	White	GN	Green	COMP	Compressor
YE	Yellow	BN	Brown		Grounding wire
RD	Red	BU	Blue	/	/
YEGN	Yellow/Green	BK	Black	/	/
VT	Violet	OG	Orange	/	/

### • Outdoor Unit

CHML-U14RK2-NG  
CHML-U18RK2-NG

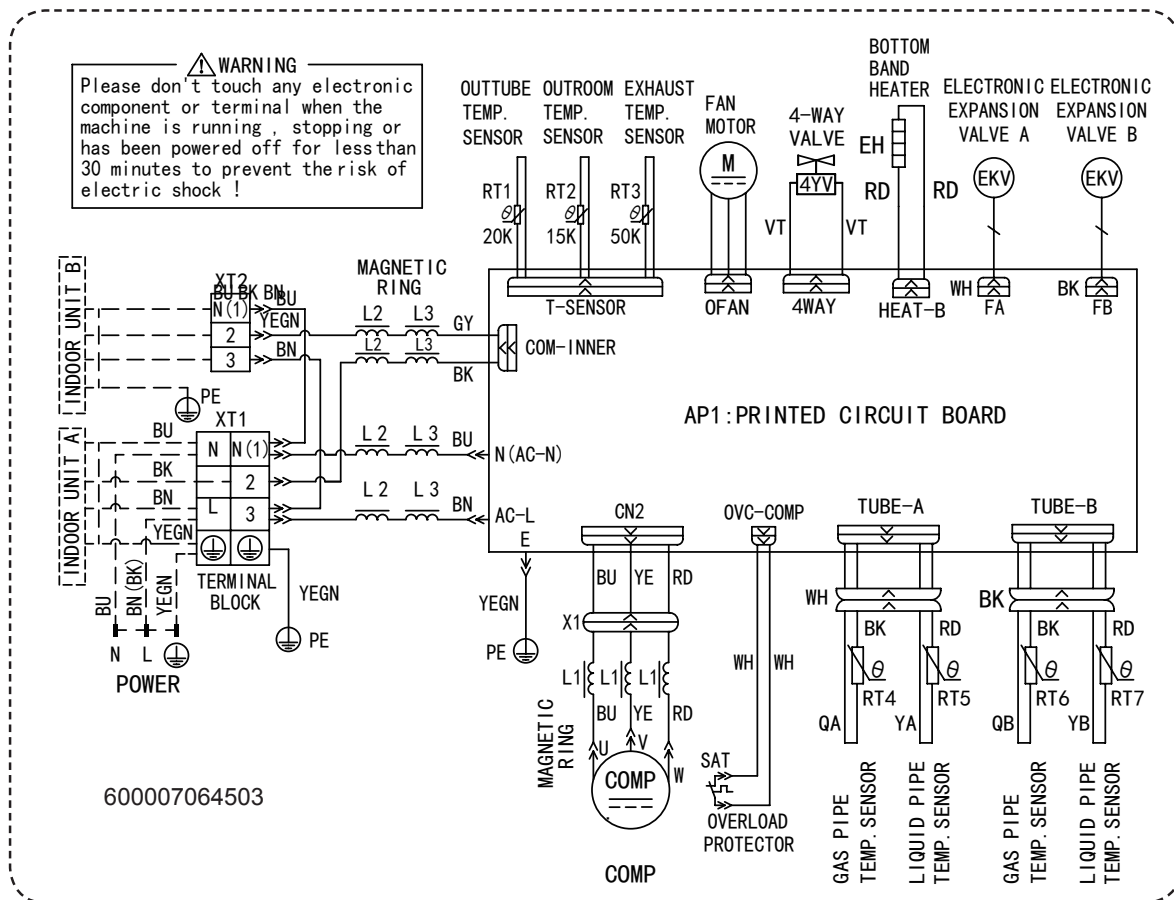

# 5. Electrical Part

CHML-U21RK3-NG  
CHML-U24RK3-NG

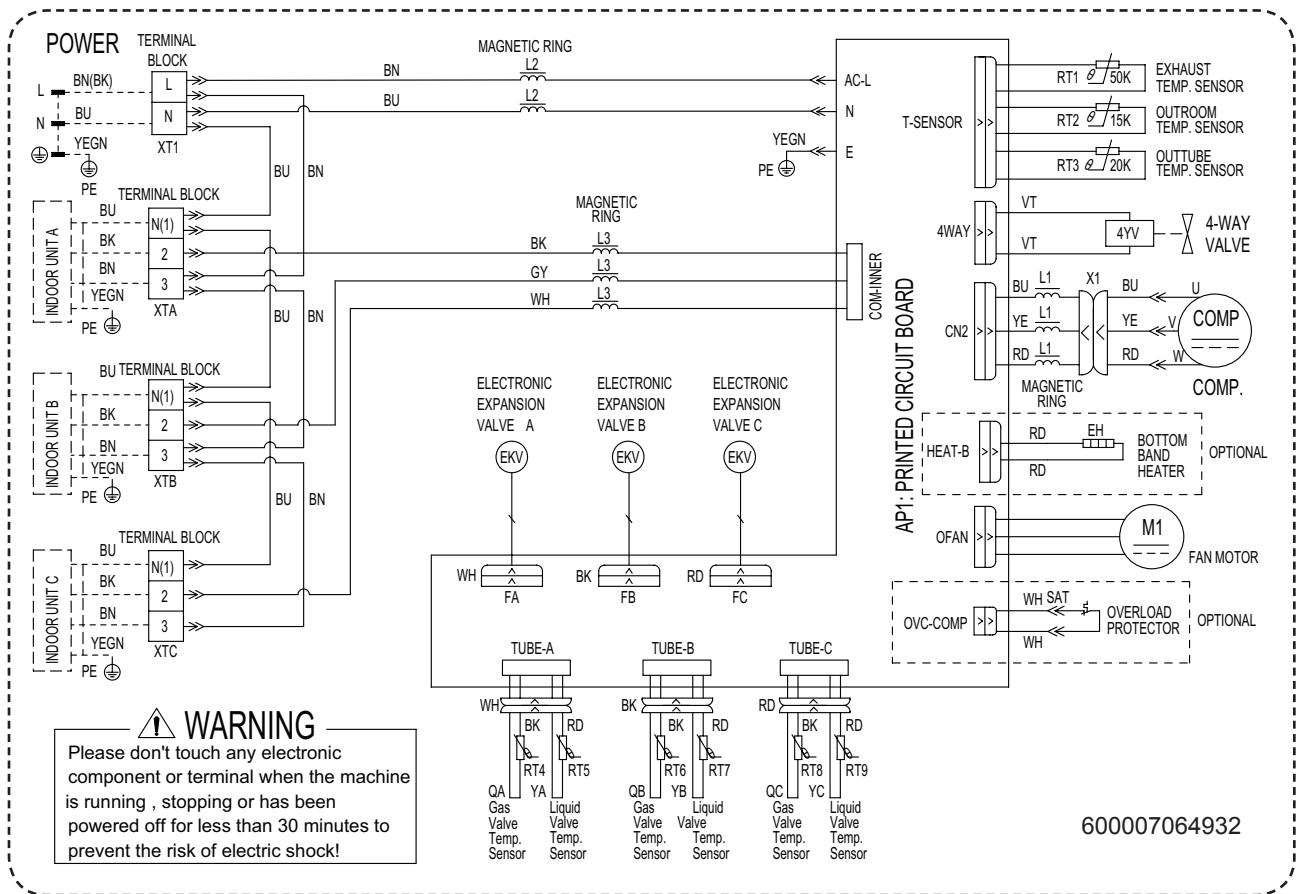

# 5. Electrical Part

CHML-U28RK4-NG

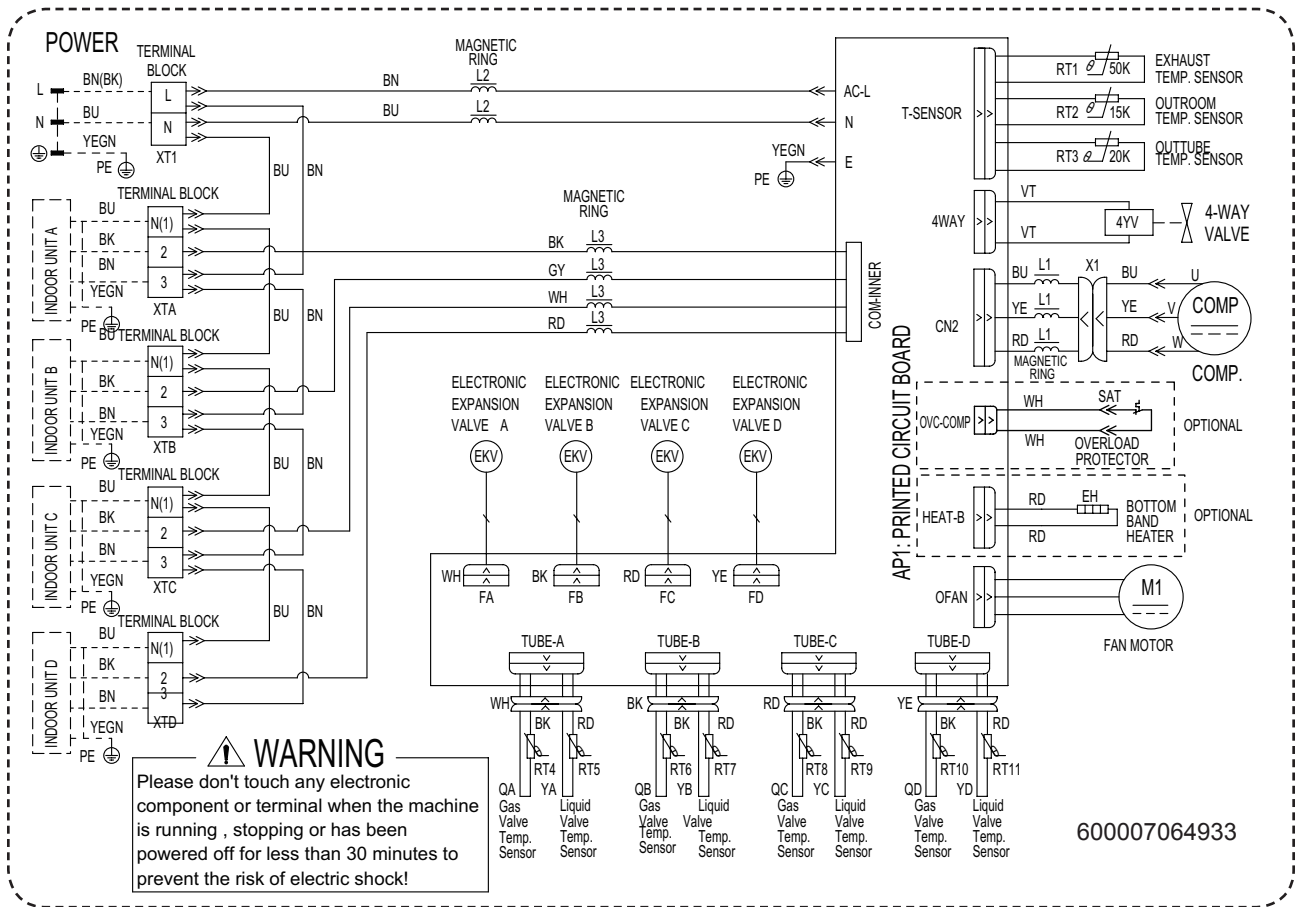

CHML-U36RK4-NG

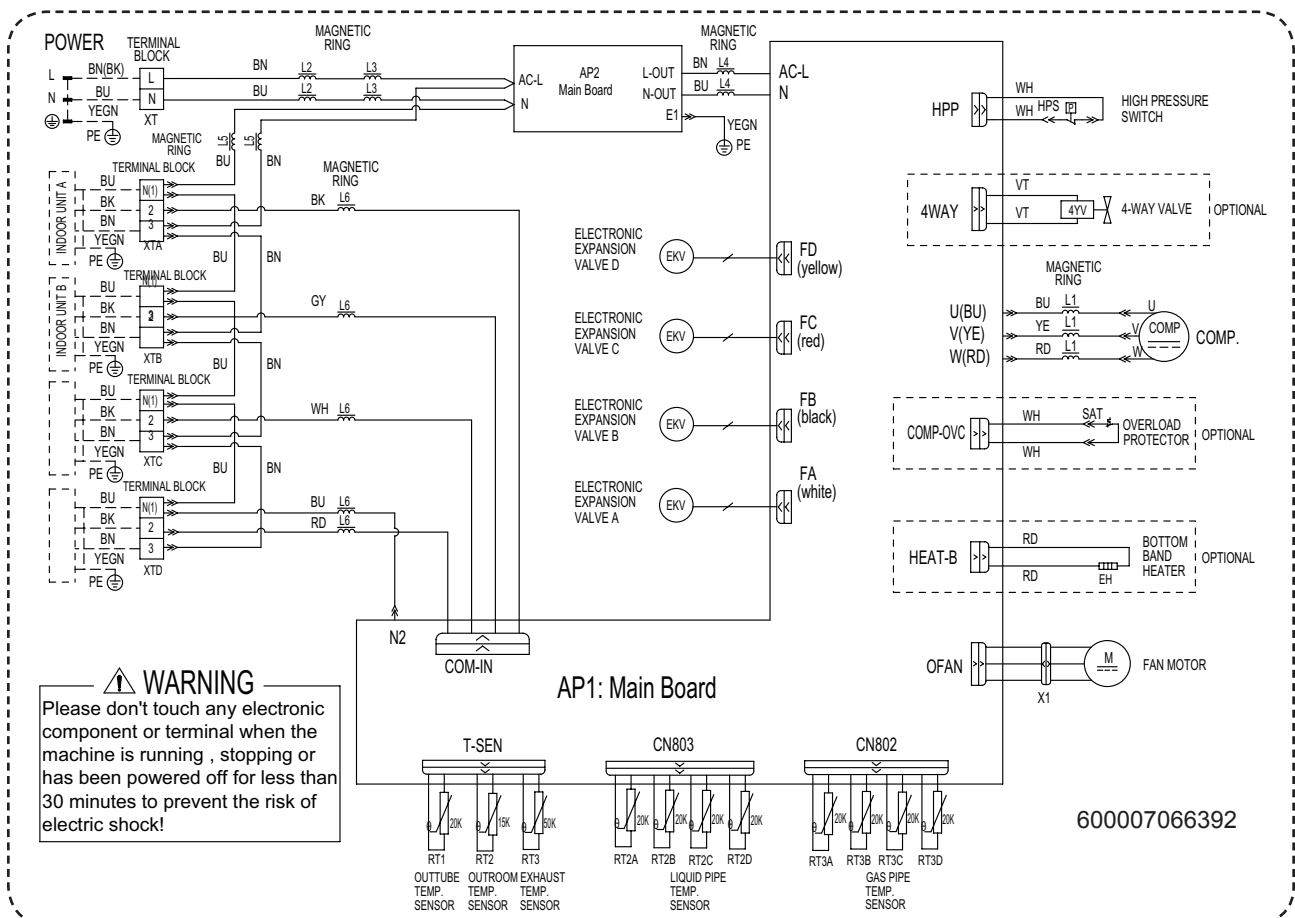



# 5. Electrical Part

CHML-U42RK5-NG

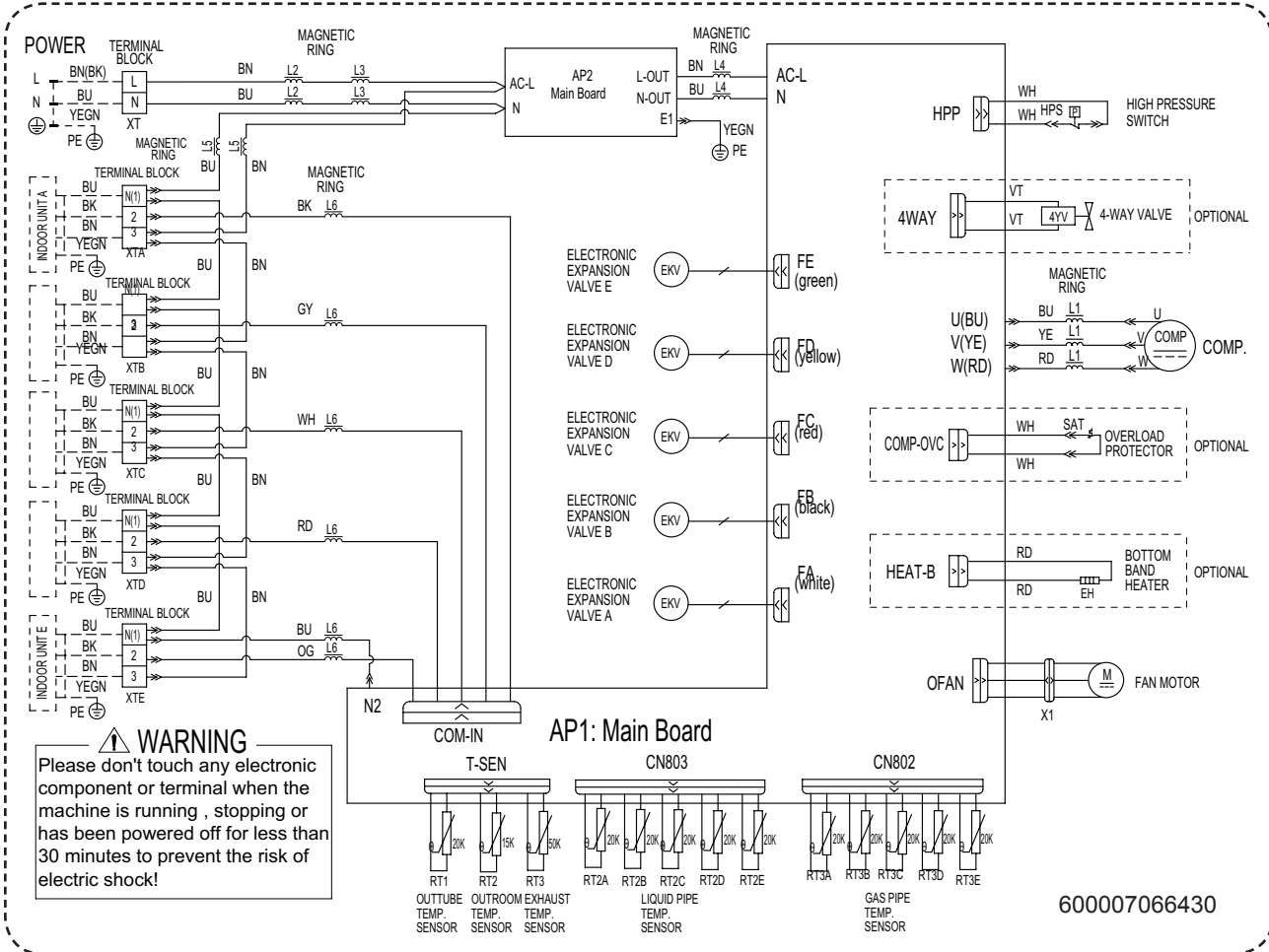

These wiring diagrams are subject to change without notice; please refer to the one supplied with the unit.

# 5. Electrical Part

## 5.2 PCB Printed Diagram

CHML-U14RK2-NG  
CHML-U18RK2-NG

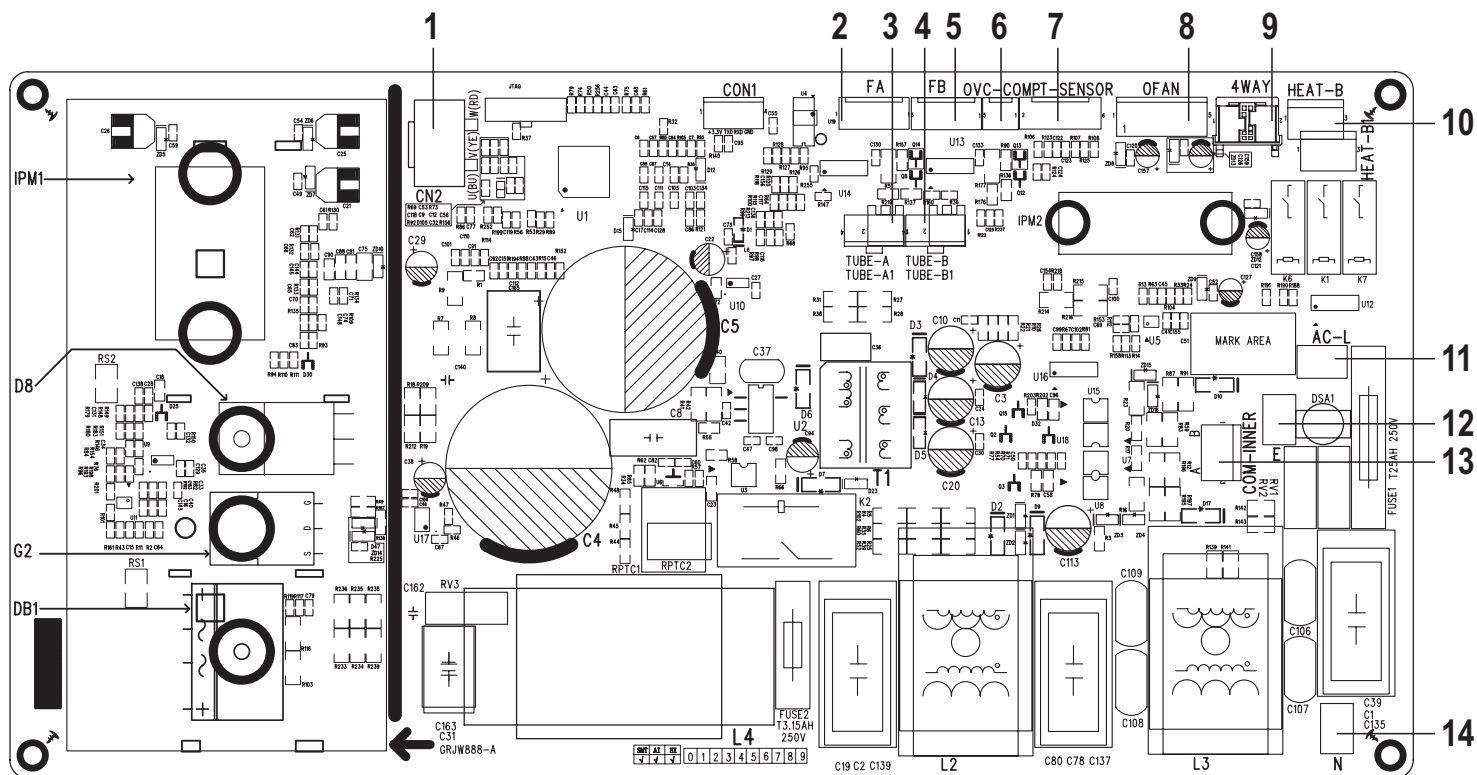

No.	Name
1	Terminal of compressor
2	Terminal of electronic expansion valve A
3	Terminal of gas-liquid valve temperature Sensor A
4	Terminal of gas-liquid valve temperature Sensor B
5	Terminal of electronic expansion valve B
6	Overload protection terminal of compressor
7	Terminal of temperature Sensor

No.	Name
8	Terminal of outdoor fan
9	Terminal of 4-way valve
10	Electric heating terminal of chassis
11	Terminal of live wire
12	Terminal of grounding wire
13	Terminal of communication wire
14	Terminal of neutral wire

# 5. Electrical Part

CHML-U21RK3-NG  
CHML-U24RK3-NG  
CHML-U28RK4-NG

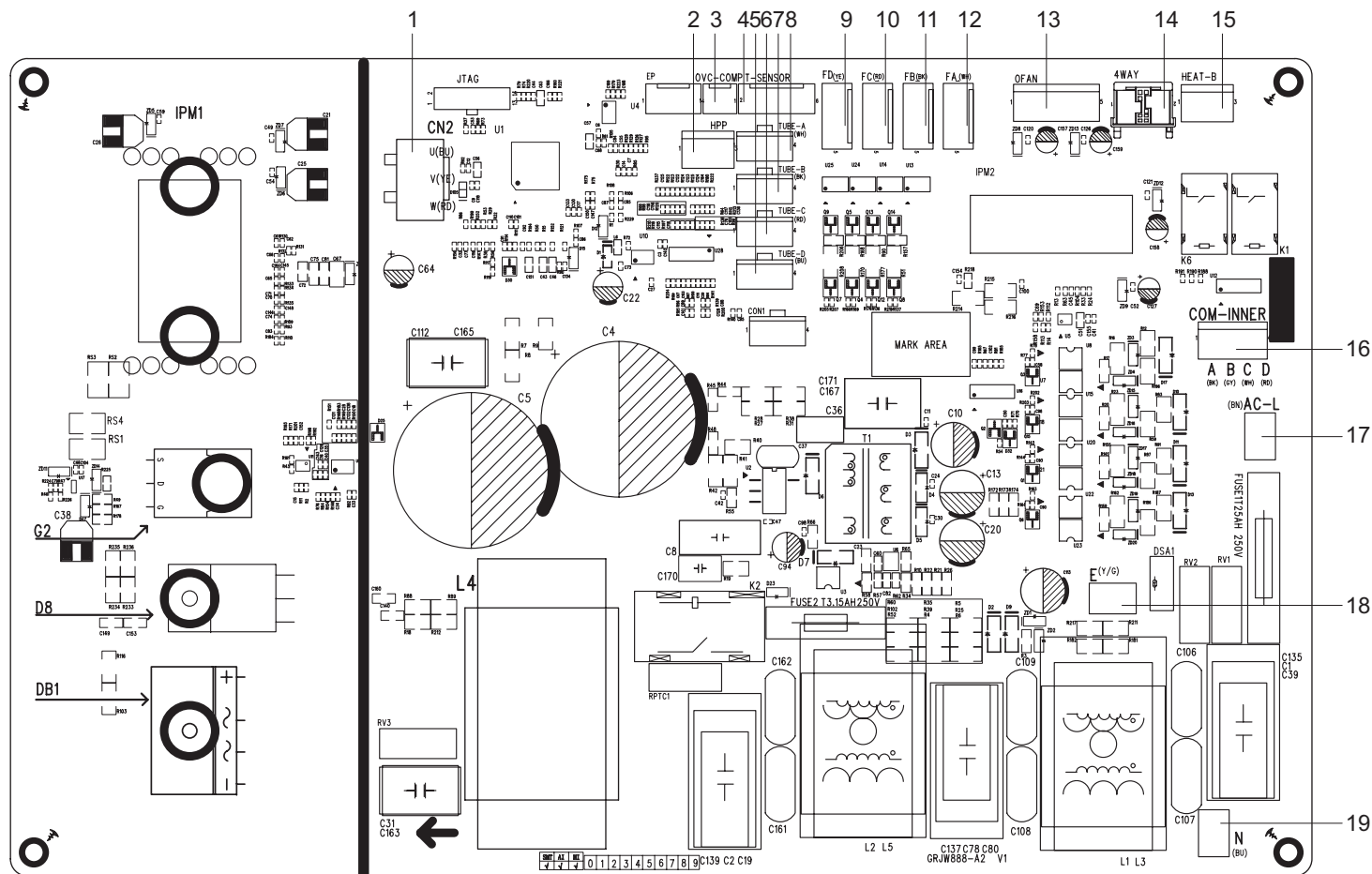

No.	Name
1	Terminal of compressor
2	Terminal of high pressure protection
3	Overload protection terminal of compressor
4	Terminal of gas-liquid valve temperature Sensor
5	Terminal of gas-liquid valve temperature Sensor
D	
6	Terminal of gas-liquid valve temperature Sensor
C	
7	Terminal of gas-liquid valve temperature Sensor
B	
8	Terminal of gas-liquid valve temperature Sensor A

No.	Name
11	Terminal of electronic expansion valve B
12	Terminal of electronic expansion valve A
13	Terminal of outdoor fan
14	Terminal of 4-way valve
15	Electric heating terminal of chassis
16	Terminal of communication wire
17	Terminal of live wire
18	Terminal of grounding wire
19	Terminal of neutral wire



# 6. Function and Control

## 1 Basic functions of the system

### 1.1 Cooling Mode

#### 1.1.1 Cooling conditions and process:

If the compressor is in stop status and start the unit for cooling operation, when one of the indoor units reaches the cooling operation condition, the unit start cooling operation; in this case, the electronic expansion valve, the outdoor fan and the compressor start operation.

#### 1.1.2 Stop in cooling operation

##### 1.1.2.1 Compressor stops

The compressor stops immediately, the outdoor fan stops after 1min.

##### 1.1.2.2 Some of the indoor units reach the stop condition (the compressor does not stop)

The compressor operates immediately according to the required frequency. For the indoor unit with no requirement, the corresponding electronic expansion valve is closed to OP.

#### 1.1.3 Cooling mode transfers to heating mode

When the unit transfers to heating mode, the 4-way valve is energized after the compressor stops for 2min. The other disposals are the same as stopping in cooling mode.

##### 1.1.4 4-way valve: in this mode, the 4-way valve is closed.

#### 1.1.5 Outdoor fan control in cooling mode

The outdoor fan starts before 5s of the starting of compressor. The outdoor fan will run in high speed for 3min after starting and then it will run in set speed. The fan shall run at every speed for at least 80s. (When the quantity of running indoor unit is changed, the unit will enter the control described in 1.3.5.1 and 1.3.5.2);

When the compressor stops, the outdoor fan runs at present speed and stops after 1min.

### 1.2 Dry Mode

1.2.1 The dry conditions and process are the same as those in cooling mode;

1.2.2 The status of 4-way valve: closed;

1.2.3 The temperature setting range: 16 ~ 30°C;

1.2.4 Protection function: the same as those in cooling mode;

1.2.5 In dry mode, the maximum value A of the capacity requirement percentage of single unit is 90% of that in cooling mode.

The open condition of the electronic expansion valve, outdoor fan and compressor is the same as those in cooling mode.

### 1.3 Heating Mode

#### 1.3.1 Heating conditions and process:

When one of the indoor units reaches the heating operation condition, the unit starts heating operation.

#### 1.3.2 Stop in heating operation:

1.3.2.1 When all the indoor units reach the stop condition, the compressor stops and the outdoor fan stops after 1min;

1.3.2.2 Some of the indoor units reach the stop condition

The compressor reduces the frequency immediately and operates according to the required frequency;

1.3.2.3 Heating mode transfers to cooling mode(dry mode), fan mode

a. The compressor stops; b. the power of 4-way valve is cut off after 2min; c. the outdoor fan stops after 1min; d. the status of 4-way valve: energized;

#### 1.3.3 Outdoor fan control in heating mode

The outdoor fan starts before 5s of the starting of compressor and then it will run in high speed for 40s;

The fan shall run at every speed for at least 80s;

When the compressor stops, the outdoor fan stops after 1min.

#### 1.3.4 Defrosting function

When the defrosting condition is met, the compressor stops; the electronic expansion valve of all indoor units open in big angle; the outdoor fan stops after 40s of the stop of compressor, meanwhile, the 4-way valve reverses the direction; after the 4-way valve reverses the direction, the compressor starts; then begin to calculate the time of defrosting, the frequency of the compressor rises to reach the defrosting frequency.

#### 1.3.5 Oil-returned control in heating mode

##### 1.3.5.1 Oil-returned condition

The whole unit is operating in low frequency for a long time.

##### 1.3.5.2 Oil-returned process in heating mode

The indoor unit displays "H1".

##### 1.3.5.3 Oil-returned finished condition in heating mode

The duration reaches 5min.

### 1.4 Fan Mode

The compressor, the outdoor fan and the 4-way valve are closed; temperature setting range is 16 ~ 30°C.

## 2 Protection Function

### 2.1 Mode Conflict Protection of indoor unit

When the setting mode is different of different indoor unit, the unit runs in below status:

a. The mode of the first operating indoor unit is the basic mode, then compare the mode of the other indoor units to see if there is a conflict. Cooling mode (dry mode) is in conflict with heating

# 6. Function and Control

mode.

b. Fan mode is in conflict with heating mode and the heating mode is the basic mode. No matter which indoor unit operates first, the unit will run in heating mode.

## 2.2 Overload protection function

When the tube temperature is a little low, the compressor raises the operation frequency; when the tube temperature is a little high, the compressor frequency is restricted or lows down the operation frequency; when the tube temperature is too high, the compressor protection stops running.

If the discharge temperature protection continuously appears for 6 times, the compressor can't resume running. The compressor can resume running after cutting off the power and then putting through the power. (if the running time of the compressor is longer than 7min, the protection times record will be cleared)

## 2.3 Discharge Protection Function

When the discharge temperature is a little low, the compressor raises the operation frequency; when the discharge temperature is a little high, the compressor frequency is restricted or lows down the operation frequency; when the discharge temperature is too high, the compressor protection stops running.

If the discharge temperature protection continuously appears for 6 times, the compressor can't resume running. The compressor can resume running after cutting off the power and then putting through the power. (if the running time of the compressor is longer than 7min, the protection times record will be cleared.)

## 2.4 Communication malfunction

Detection of the quantity of installed indoor units:

After 3min of energizing, if the outdoor unit does not receive the communication data of certain indoor unit, the outdoor unit will judge that indoor unit is not installed and will treat it as it is not installed. If the outdoor unit receives the communication data of that indoor unit later, the outdoor unit will treat that unit as it is installed.

## 2.5 Overcurrent Protection

a. Overcurrent protection of complete unit; b. phase wire current protection; c. compressor phase current protection

## 2.6 Compressor high-pressure protection

2.6.1 When the high-pressure switch is detected cut off for 3s continuously, the compressor will enter high-pressure protection as it stops when reaching set temperature. Meanwhile, the outdoor unit will send the signal of "high-pressure protection" to the indoor units;

2.6.2 After the appearance of high-pressure protection, when the high-pressure switch is detected closed for 6s continuously, the compressor can resume running only after cutting off the power

and then putting through the power.

## 2.7 Compressor overload protection

If the compressor overload switch is detected having movement, the indoor unit will display the corresponding malfunction as it stops when the indoor temperature reaching set temperature. When the compressor stops for more than 3min and the compressor overload switch is reset, the unit will resume operation status automatically. If the protection appears for more than 6 times (if the running time of the compressor is longer than 30min, the protection times record will be cleared), the unit can not resume operation status automatically, but can resume running only after cutting off the power and then putting through the power.

## 2.8 Compressor Phase-lacking Protection

When the compressor starts, if one of the three phases is detected open, the compressor will enter phase-lacking protection. The malfunction will be cleared after 1min, the unit will restart and then detect if there is still has phase-lacking protection. If the phase-lacking protection is detected for 6 times continuously, the compressor will not restart but can resume running only after cutting off the power and then putting through the power. If the running time of the compressor is longer than 7min, the protection times record will be cleared.

## 2.9 IPM Protection

2.9.1 When the IPM module protection is detected, the unit will stop as the indoor temperature reaching set temperature, PFC is closed, display IPM protection malfunction. After the compressor stops for 3min, the unit will resume operation status automatically; if the IPM protection is detected for more than 6 times continuously (If the running time of the compressor is longer than 7min, the protection times record will be cleared), the system will stop and send the signal of module protection to indoor unit. The unit can not resume operation status automatically, but can resume running only after cutting off the power and then putting through the power.

2.9.2 IPM module overheating protection

2.9.2.1 When  $TIPM > 85^{\circ}\text{C}$ , prohibit to raise frequency;

2.9.2.2 When  $TIPM \geq 90^{\circ}\text{C}$ , the operation frequency of compressor lows down by 15% every 90s according to the present capacity requirement of the complete unit. It will keep 90s after lowing down the frequency. After lowing down the frequency, if  $TIPM \geq 90^{\circ}\text{C}$ , the unit will circulate the above movement until reaching the minimum frequency; if  $85^{\circ}\text{C} < TIPM < 90^{\circ}\text{C}$ , the unit will run at this frequency; when  $TIPM = 85^{\circ}\text{C}$ , the unit will run at the frequency according to the capacity requirement;

2.9.2.3 When  $TIPM \geq 95^{\circ}\text{C}$ , the compressor stops. After the compressor stops for 3min, if  $TIPM < 85^{\circ}\text{C}$ , the compressor and the outdoor fan will resume operation.



# 7. Notes for Installation and Maintenance

## Safety Precautions: Important!

Please read the safety precautions carefully before installation and maintenance.

The following contents are very important for installation and maintenance.

Please follow the instructions below.

- The installation or maintenance must accord with the instructions.
- Comply with all national electrical codes and local electrical codes.
- Pay attention to the warnings and cautions in this manual.
- All installation and maintenance shall be performed by distributor or qualified person.
- All electric work must be performed by a licensed technician according to local regulations and the instructions given in this manual.
- Be caution during installation and maintenance. Prohibit incorrect operation to prevent electric shock, casualty and other accidents.



## Warnings

### Electrical Safety Precautions:

1. Cut off the power supply of air conditioner before checking and maintenance.
2. The air condition must apply specialized circuit and prohibit share the same circuit with other appliances.
3. The air conditioner should be installed in suitable location and ensure the power plug is touchable.
4. Make sure each wiring terminal is connected firmly during installation and maintenance.
5. Have the unit adequately grounded. The grounding wire can't be used for other purposes.
6. Must apply protective accessories such as protective boards, cable-cross loop and wire clip.
7. The live wire, neutral wire and grounding wire of power supply must be corresponding to the live wire, neutral wire and grounding wire of the air conditioner.
8. The power cord and power connection wires can't be pressed by hard objects.
9. If power cord or connection wire is broken, it must be replaced by a qualified person.
10. If the power cord or connection wire is not long enough, please get the specialized power cord or connection wire from the manufacture or distributor. Prohibit prolong the wire by yourself.
11. For the air conditioner without plug, an air switch must be installed in the circuit. The air switch should be all-pole parting and the contact parting distance should be more than 3m.
12. Make sure all wires and pipes are connected properly and

the valves are opened before energizing.

13. Check if there is electric leakage on the unit body. If yes, please eliminate the electric leakage.

14. Replace the fuse with a new one of the same specification if it is burnt down; don't replace it with a cooper wire or conducting wire.

15. If the unit is to be installed in a humid place, the circuit breaker must be installed.

### Installation Safety Precautions:

1. Select the installation location according to the requirement of this manual.(See the requirements in installation part)
2. Handle unit transportation with care; the unit should not be carried by only one person if it is more than 20kg.
3. When installing the indoor unit and outdoor unit, a sufficient fixing bolt must be installed; make sure the installation support is firm.
4. Ware safety belt if the height of working is above 2m.
5. Use equipped components or appointed components during installation.
6. Make sure no foreign objects are left in the unit after finishing installation.

### Refrigerant Safety Precautions:

When refrigerant leaks or requires discharge during installation, maintenance, or disassembly, it should be handled by certified professionals or otherwise in compliance with local laws and regulations.

1. Avoid contact between refrigerant and fire as it generates poisonous gas; Prohibit prolong the connection pipe by welding.
2. Apply specified refrigerant only. Never have it mixed with any other refrigerant. Never have air remain in the refrigerant line as it may lead to rupture or other hazards.
3. Make sure no refrigerant gas is leaking out when installation is completed.
4. If there is refrigerant leakage, please take sufficient measure to minimize the density of refrigerant.
5. Never touch the refrigerant piping or compressor without wearing glove to avoid scald or frostbite.

Improper installation may lead to fire hazard, explosion, electric shock or injury.

# 7. Notes for Installation and Maintenance

## Safety Precautions for Installing and Relocating the Unit:

To ensure safety, please be mindful of the following precautions.

### WARNINGS

**1. When installing or relocating the unit, be sure to keep the refrigerant circuit free from air or substances other than the specified refrigerant.**

Any presence of air or other foreign substance in the refrigerant circuit will cause system pressure rise or compressor rupture, resulting in injury.

**2. When installing or moving this unit, do not charge the refrigerant which is not comply with that on the nameplate or unqualified refrigerant.**

Otherwise, it may cause abnormal operation, wrong action, mechanical malfunction or even series safety accident.

**3. When refrigerant needs to be recovered during relocating or repairing the unit, be sure that the unit is running in cooling mode. Then, fully close the valve at high pressure side (liquid valve). About 30-40 seconds later, fully close the valve at low pressure side (gas valve), immediately stop the unit and disconnect power. Please note that the time for refrigerant recovery should not exceed 1 minute.**

If refrigerant recovery takes too much time, air may be sucked in and cause pressure rise or compressor rupture, resulting in injury.

**4. During refrigerant recovery, make sure that liquid valve and gas valve are fully closed and power is disconnected before detaching the connection pipe.**

If compressor starts running when stop valve is open and connection pipe is not yet connected, air will be sucked in and cause pressure rise or compressor rupture, resulting in injury.

**5. When installing the unit, make sure that connection pipe is securely connected before the compressor starts running.**

If compressor starts running when stop valve is open and connection pipe is not yet connected, air will be sucked in and cause pressure rise or compressor rupture, resulting in injury.

**6. Prohibit installing the unit at the place where there may be leaked corrosive gas or flammable gas.**

If there leaked gas around the unit, it may cause explosion and other accidents.

**7. Do not use extension cords for electrical connections. If the electric wire is not long enough, please contact a local service center authorized and ask for a proper electric wire.**

Poor connections may lead to electric shock or fire.

**8. Use the specified types of wires for electrical connections between the indoor and outdoor units. Firmly clamp the wires so that their terminals receive no external stresses.**

Electric wires with insufficient capacity, wrong wire connections and insecure wire terminals may cause electric shock or fire.



# 7. Notes for Installation and Maintenance

## Safety Precautions for Refrigerant

●To realize the function of the air conditioner unit, a special refrigerant circulates in the system. The used refrigerant is the fluoride R32, which is specially cleaned. The refrigerant is flammable and inodorous. Furthermore, it can lead to explosion under certain conditions. But the flammability of the refrigerant is very low. It can be ignited only by fire.

●Compared to common refrigerants, R32 is a nonpolluting refrigerant with no harm to the ozoneosphere. The influence upon the greenhouse effect is also lower. R32 has got very good thermodynamic features which lead to a really high energy efficiency. The units therefore need a less filling.

### WARNING:

●Do not use means to accelerate the defrosting process or to clean, other than those recommended by the manufacturer.

Should repair be necessary, contact your nearest authorized Service Centre. Any repairs carried out by unqualified personnel may be dangerous. The appliance shall be stored in a room without continuously operating ignition sources. (For example: open flames, an operating gas appliance or an operating electric heater.)

●Do not pierce or burn.

●Appliance shall be installed, operated and stored in a room with a floor area larger than  $Xm^2$ .

●Appliance filled with flammable gas R32. For repairs, strictly follow manufacturers instructions only. Be aware that refrigerants not contain odour.

●Read specialists manual.

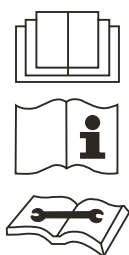

## Safety Operation of Flammable Refrigerant

### Qualification requirement for installation and maintenance man

●All the work men who are engaging in the refrigeration system should bear the valid certification awarded by the authoritative organization and the qualification for dealing with the refrigeration system recognized by this industry. If it needs other technician to maintain and repair the appliance, they should be supervised by the person who bears the qualification for using the flammable refrigerant.

●It can only be repaired by the method suggested by the equipments manufacturer.

### Installation notes

●The air conditioner is not allowed to use in a room that has running fire (such as fire source, working coal gas ware, operating heater).

●It is not allowed to drill hole or burn the connection pipe.

●The air conditioner must be installed in a room that is larger than the minimum room area.

The minimum room area is shown on the nameplate or following table a.

●Leak test is a must after installation.

table a - Minimum room area (  $m^2$  )

Charge amount (kg)	Floor location	Window mounted	Wall mounted	Ceiling mounted
≤1.2	4	4	4	4
1.3	14.5	5.2	4	4
1.4	16.8	6.1	4	4
1.5	19.3	7	4	4
1.6	22	7.9	4	4
1.7	24.8	8.9	4	4
1.8	27.8	10	4	4
1.9	31	11.2	4	4
2.0	34.3	12.4	4	4
2.1	37.8	13.6	4.2	4
2.2	41.5	15	4.6	4
2.3	45.4	16.3	5	4
2.4	49.4	17.8	5.5	4
2.5	53.6	19.3	6	4

### Maintenance notes

●Check whether the maintenance area or the room area meet the requirement of the nameplate.

— Its only allowed to be operated in the rooms that meet the requirement of the nameplate.

●Check whether the maintenance area is well-ventilated.

— The continuous ventilation status should be kept during the operation process.

●Check whether there is fire source or potential fire source in the maintenance area.

— The naked flame is prohibited in the maintenance area; and the “no smoking” warning board should be hanged.

# 7. Notes for Installation and Maintenance

- Check whether the appliance mark is in good condition.

— Replace the vague or damaged warning mark.

## Welding

- If you should cut or weld the refrigerant system pipes in the process of maintaining, please follow the steps as below:

a. Shut down the unit and cut power supply

b. Eliminate the refrigerant

c. Vacuuming

d. Clean it with N<sub>2</sub> gas

e. Cutting or welding

f. Carry back to the service spot for welding

- Make sure that there isn't any naked flame near the outlet of the vacuum pump and its well-ventilated.

- The refrigerant should be recycled into the specialized storage tank.

## Filling the refrigerant

- Use the refrigerant filling appliances specialized for R32. Make sure that different kinds of refrigerant won't contaminate with each other.

- The refrigerant tank should be kept upright at the time of filling refrigerant.

- Stick the label on the system after filling is finished (or haven't finished).

- Don't overfilling.

- After filling is finished, please do the leakage detection before test running; another time of leak detection should be done when its removed.

## Safety instructions for transportation and storage

- Please use the flammable gas detector to check before unload and open the container.

- No fire source and smoking.

- According to the local rules and laws.

# 7. Notes for Installation and Maintenance

## Main Tools for Installation and Maintenance

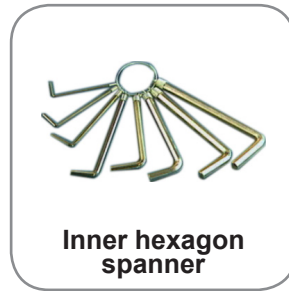

# 8. Installation

## Installation Procedures

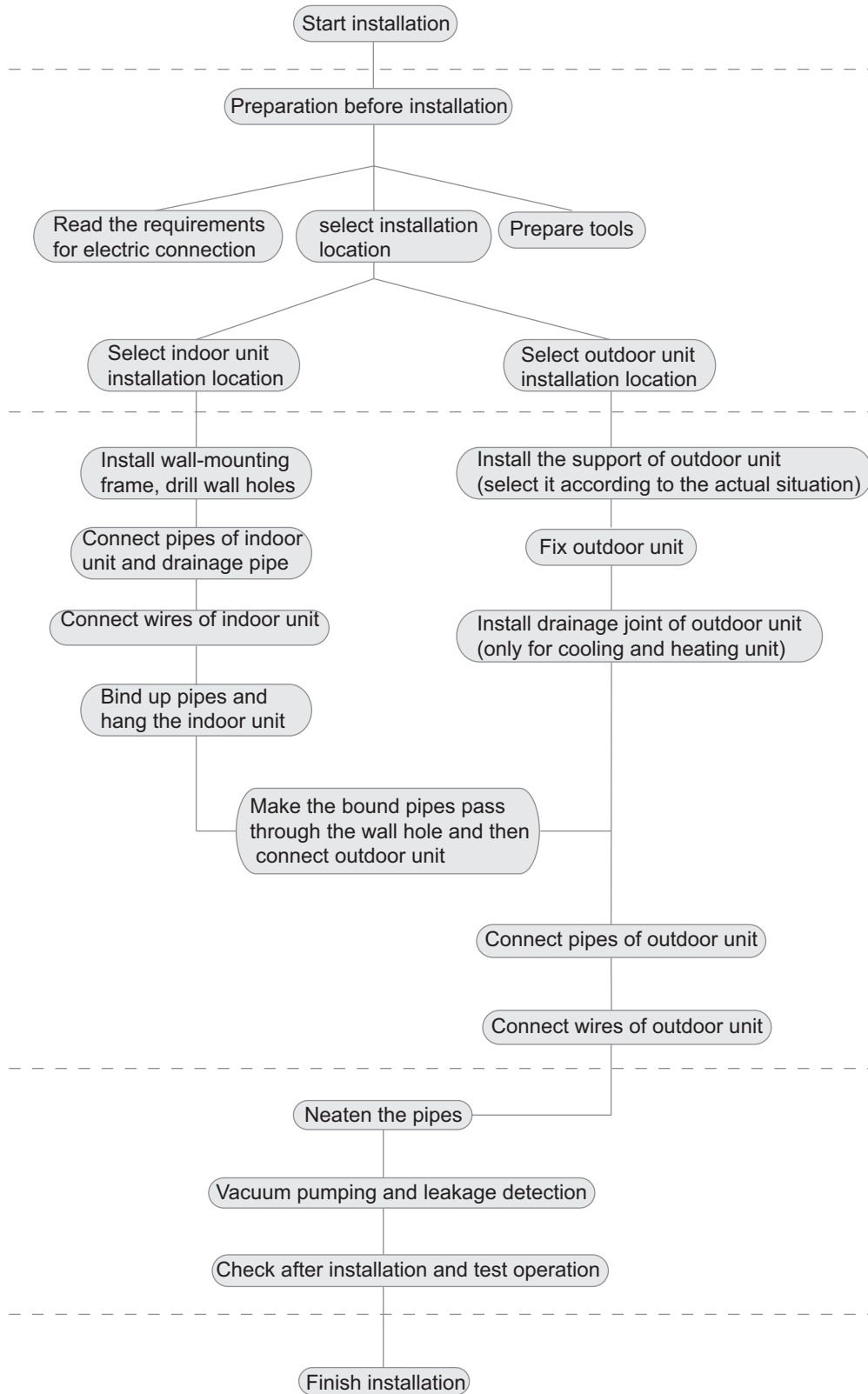

Note: this flow is only for reference; please find the more detailed installation steps in this section.

# 8. Installation

## 8.1 Electrical Connections

1. Remove the handle at the right side plate of the outdoor unit (one screw).
2. Remove the cable clamp, connect the power connection cable with the terminal at the row of connection and fix the connection. The fitting line distributing must be consistent with the indoor unit terminal of line bank. Wiring should meet that of indoor unit.
3. Fix power connection wire by wire clamp.
4. Ensure wire has been fixed well.
5. Install the handle.

△ Including an air switch with suitable capacity, please note the following table. Air switch should be included magnet buckle and heating buckle function, it can protect the circuit-short and overload. (Caution: please do not use the fuse only for protect the circuit)

Air-conditioner	Air switch capacity
CHML-U14RK2-NG CHML-U18RK2-NG	16A
CHML-U21RK3-NG CHML-U24RK3-NG CHML-U28RK4-NG	25A
CHML-U36RK4-NG CHML-U42RK5-NG	32A

- △ An all-pole disconnection switch having a contact separation of at least 3mm in all pole should be connected in fixed wiring.
- △ Wrong wire connection may cause malfunction of some electric components. After fixing cable, ensure that leads between connection to fixed point have some space.
- △ For 14K/18K, the connection pipes and the connecting wirings of the unit A, unit B must be corresponding to each other respective.
- △ For 21K/24K, the connection pipes and the connecting wirings of the unit A, unit B, unit C must be corresponding to each other respective.
- △ For 28K/36K, the connection pipes and the connecting wirings of the unit A, unit B, unit C, unit D must be corresponding to each other respective.
- △ For 42K, the connection pipes and the connecting wirings of the unit A, unit B, unit C, unit D, unit E must be corresponding to each other respective.
- △ The appliance shall be installed in accordance with national wiring regulations.

Note: the above figures are only intended to be a simple diagram of the appliance and may not correspond to the appearance of the units that have been purchased.

### 14K / 18K

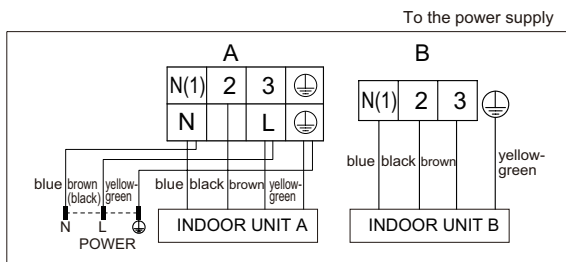
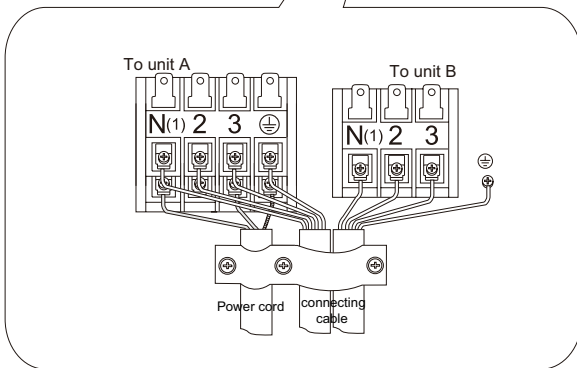
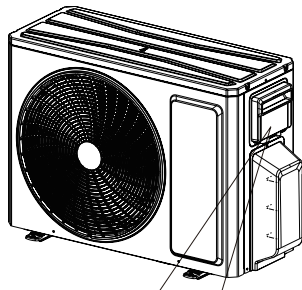

### 21K / 24K

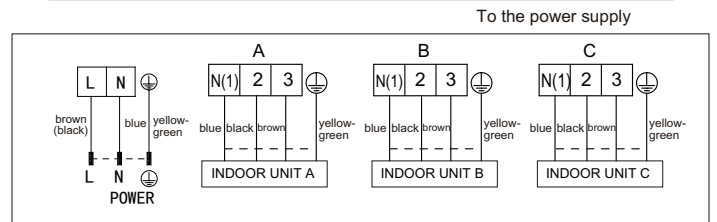
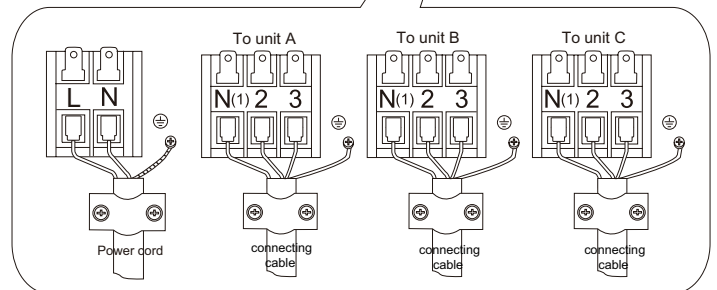
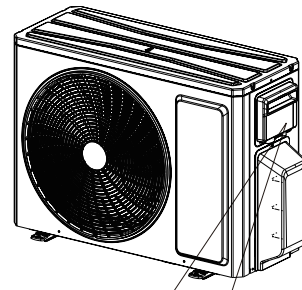

# 8. Installation

28K / 36K

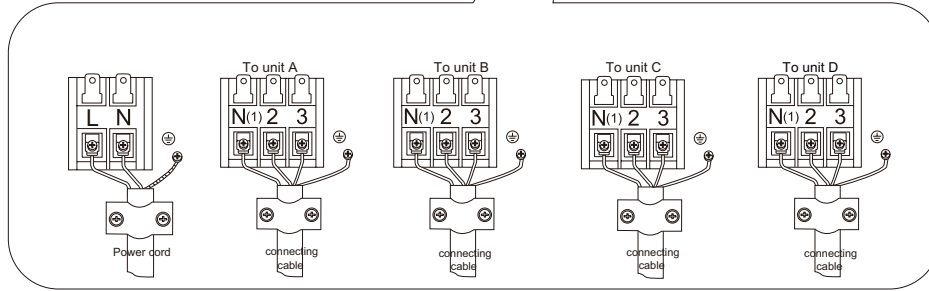
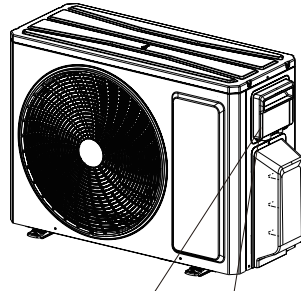

To the power supply

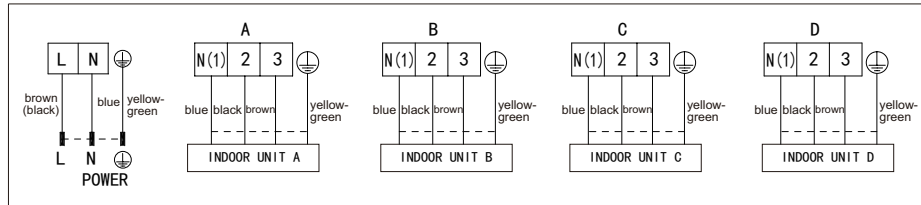

42K

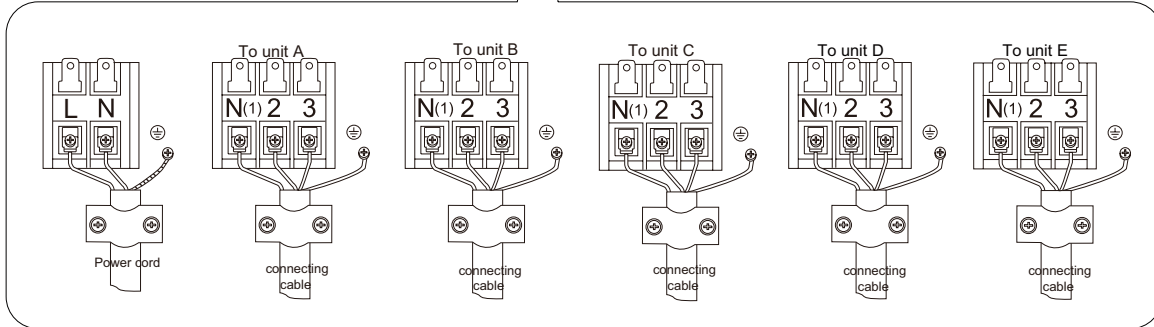
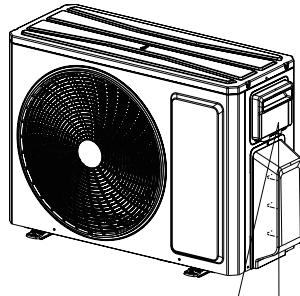

To the power supply

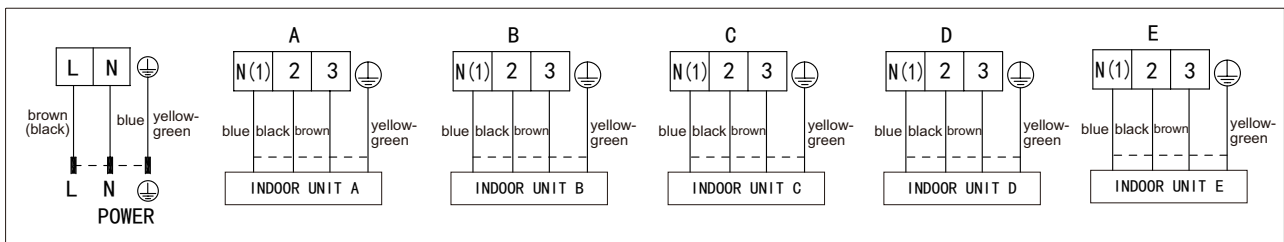

# 8. Installation

## 8.2 Installing the Outdoor Unit

▲ Use bolts to secure the unit to a flat, solid floor.

When mounting the unit on a wall or the roof, make sure the support is firmly secured so that it cannot move in the event of intense vibrations or a strong wind.

▲ Do not install the outdoor unit in pits or air vents.

### Installing the pipes

▲ Use suitable connecting pipes and equipment for the refrigerant R32.

Models(m)	14Kx2 /18Kx2	21Kx3 /24Kx3	28Kx4	36Kx4	42Kx5
Max. connection pipe length	40	60	70	80	100
Max. connection pipe length (Simple one indoor unit)	20	20	20	25	25

The sum of the capacity codes of the indoor units should be among 50%-150% of that of the outdoor unit.

▲ The refrigerant pipes must not exceed the maximum heights 15m(14~28K) or 25m(36~42K).

▲ Wrap all the refrigerant pipes and joints.

▲ Tighten the connections using two wrenches working in opposite directions.

### Caution: Installation Must be Performed in Accordance with the NEC/CEC by Authorized Personnel Only.

Humid air left inside the refrigerant circuit can cause compressor malfunction. After having connected the indoor and outdoor units, bleed the air and humidity from the refrigerant circuit using a vacuum pump.

- (1) Unscrew and remove the caps from the 2-way and 3-way valves.
- (2) Unscrew and remove the cap from the service valve.
- (3) Connect the vacuum pump hose to the service valve.
- (4) Operate the vacuum pump for 10-15 minutes until an absolute vacuum of 10 mm Hg has been reached.
- (5) With the vacuum pump still in operation, close the low-pressure knob on the vacuum pump coupling. Stop the vacuum pump.
- (6) Open the 2-way valve by 1/4" turn and then close it after 10 seconds. Check all the joints for leaks using liquid soap or an electronic leak device.
- (7) Turn the body of the 2-way and 3-way valves. Disconnect the vacuum pump hose.
- (8) Replace and tighten all the caps on the valves.

Piping size (inch)	Twisting moment (N·m)
Φ1/4	15-20
Φ3/8	35-40
Φ1/2	60-65
Φ5/8	45-50
Φ3/4	70-75

(9) If the specification of the outdoor unit's valve is unsuitable for the specification of the indoor unit, a conversion joint is needed to match the outdoor unit's valve and connection pipe, as shown in following.

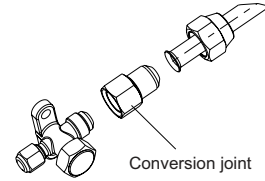

### Install the drain fitting and the drain hose(for model with heat pump only)

Condensation is produced and flows from the outdoor unit when the appliance is operating in the heating mode. In order not to disturb neighbours and to respect the environment, install a drain fitting and a drain hose to channel the condensate water. Install the drain fitting and rubber washer on the outdoor unit chassis and connect a drain hose to it as shown in the figure.

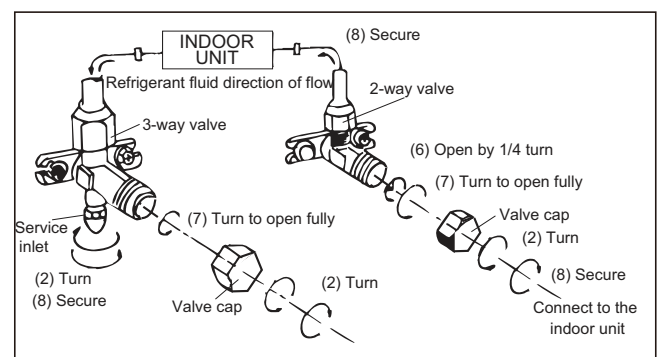
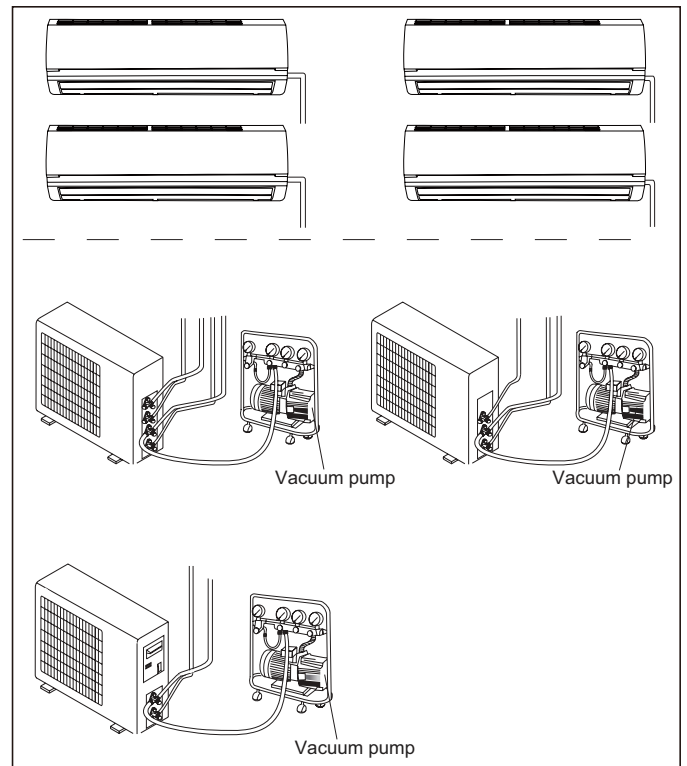
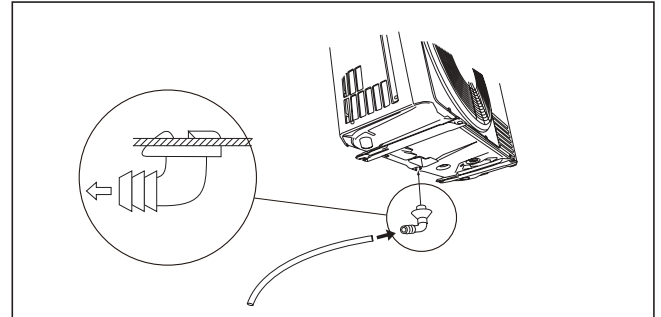



# 8. Installation

## 8.3 Installation Dimension Diagram

- ⚠ Use suitable instruments for the refrigerant R32.
- ⚠ Do not use any other refrigerant than R32.
- ⚠ Do not use mineral oils to clean the unit.

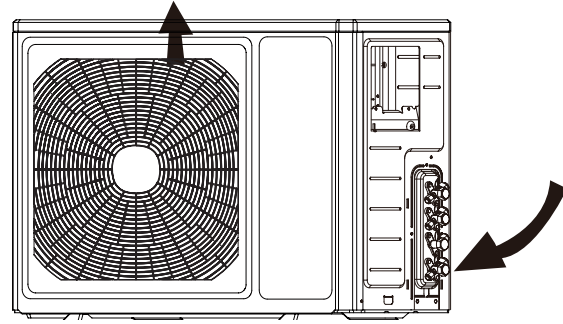

- ⚠ The installation must be done by trained and qualified service personnel with reliability according to this manual.
- ⚠ Contact service center before installation to avoid the malfunction due to unprofessional installation.
- ⚠ When picking up and moving the units, you must be guided by trained and qualified person.
- ⚠ Ensure that the recommended space is left around the appliance.

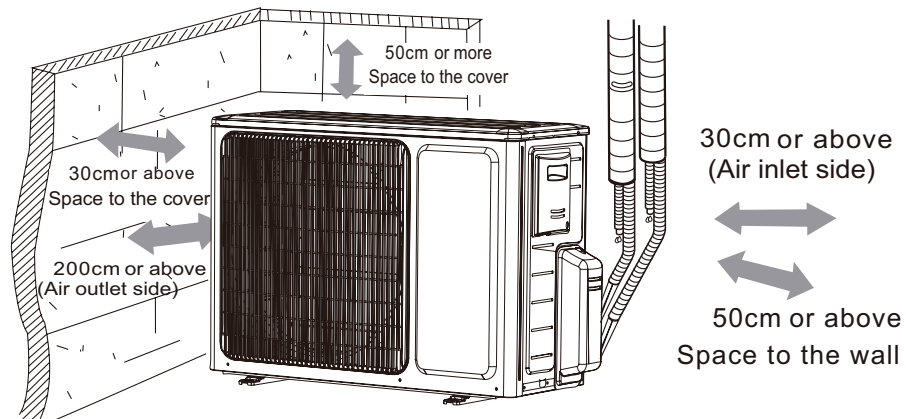



# 8. Installation

## 8.4 Check after Installation

Check Items	Problems Owing to Improper Installation
Is the installation reliable?	The unit may drop, vibrate or make noises
Has the gas leakage been checked?	May cause unsatisfactory cooling (heating) effect
Is the thermal insulation of the unit sufficient?	May cause condensation and water dropping
Is the drainage smooth?	May cause condensation and water dropping
Does the power supply voltage accord with the rated voltage specified on the nameplate?	The unit may bread down or the components may be burned out
Are the lines and pipelines correctly installed?	The unit may bread down or the components may be burned out
Has the unit been safely grounded?	Risk of electrical leakage
Are the models of lines in conformity with requirements?	The unit may bread down or the components may be burned out
Are there any obstacles near the air inlet and outlet of the indoor and outdoor units?	The unit may bread down or the components may be burned out
Have the length of refrigerating pipe and refrigerant charge amount been recorded?	It is not easy to decide the charge amount of refrigerant.

# 9. Maintenance

## 9.1 Precautions before Performing Inspection or Repair

There are high-capacity electrolytic capacitors on the outdoor mainboard. Thus, even the power is cut off, there is high voltage inside the capacitors and it needs more than 20min to reduce the voltage to safety value. Touching the electrolytic capacitor within 20min after cutting the power will cause electric shock. If maintenance is needed, follow the steps below to discharge electricity of electrolytic capacitor after power off.

(1) Open the top cover of outdoor unit and then remove the cover of electric box cover.

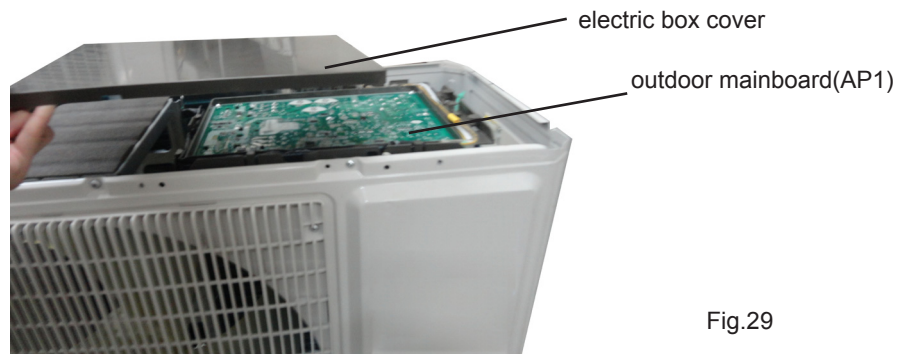

Fig.29

(2) As shown in the fig below, connect the plug of discharge resistance (about 100ohm, 20W) (if there is no discharge resistance, you can use the plug of soldering iron) to point A and B of electrolytic capacitor. There will be sparks when touching them. Press them forcibly for 30s to discharge electricity of electrolytic capacitor.

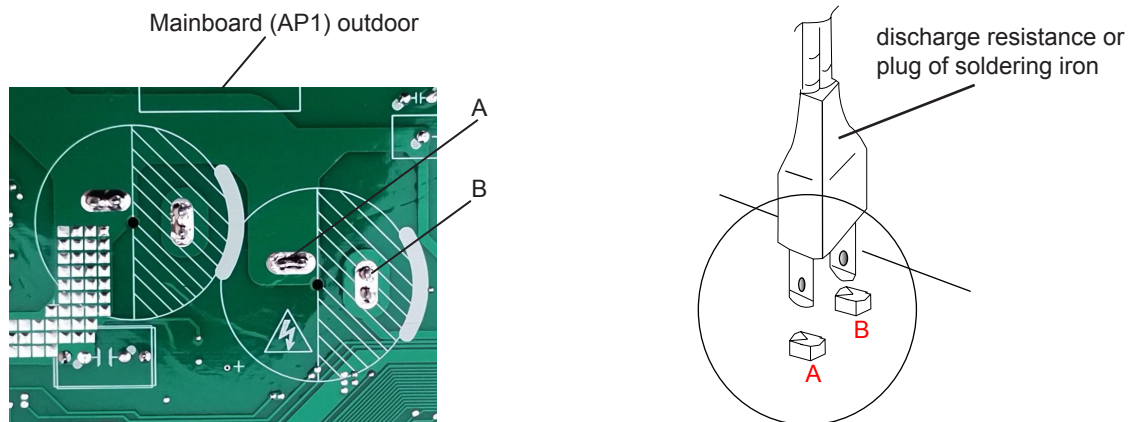

Fig.30

(3) After finish discharging electricity, measure the voltage between point A and B with universal meter to make sure if electricity discharging is completed, in order to prevent electric shock. If the voltage between the two points is below 20V, you can perform maintenance safely.

# 9. Maintenance

## 9.2 Flashing LED of Indoor/Outdoor Unit and Primary Judgement

### 1. Requirement of malfunction display

When several malfunctions happen at the same time, malfunction codes will be displayed circularly.

### 2. Malfunction display method

(1) Hardware malfunction: it will be displayed immediately, please refer to “Malfunction status sheet”;

(2) Operation status: it will be displayed immediately, please refer to “Malfunction status sheet”;

(3) Other malfunction: It will be displayed after the compressor has been stopped for 200s, please refer to “Malfunction status sheet”.

(Note: when the compressor starts up again, malfunction display waiting time (200s) will be cleared.)

### 3. Malfunction display control

Indoor unit displays malfunction code as shown in the sheet below. ODU communication light will be off for 1s and then blink for 1s circularly.

Malfunction status sheet		
Malfunction name	Malfunction type	Nixie tube
Zero cross detection circuit malfunction	Hardware malfunction	U8
Malfunction protection of jumper cap	Hardware malfunction	C5
Feedback of without IDU motor	Hardware malfunction	H6
Indoor ambient temperature sensor is open/short circuited	Hardware malfunction	F1
Indoor evaporator temperature sensor is open/short circuited	Hardware malfunction	F2
Liquid valve temperature sensor is open/short circuited	Hardware malfunction	b5
Gas valve temperature sensor is open/short circuited	Hardware malfunction	b7
Modular temperature sensor is open/short circuited	Hardware malfunction	P7
Outdoor ambient temperature sensor is open/short circuited	Hardware malfunction	F3
Outdoor condenser middle pipe temperature sensor is open/short circuited	Hardware malfunction	F4
Outdoor discharge temperature sensor is open/short circuited	Hardware malfunction	F5
Communication malfunction	Hardware malfunction	E6
Malfunction of phase current detection circuit for compressor	Hardware malfunction	U1
Compressor demagnetization protection	Viewing malfunction code through remote controller within 200s; displayed directly on nixietube after 200s	HE
Malfunction of voltage dropping for DC bus-bar		U3
Module high temperature protection		P8
Refrigerant lacking or blockage protection of system (not available for residential ODU)		F0
Charging malfunction of capacitor	Hardware malfunction	PU
High pressure protection of system	Hardware malfunction	E1
Low pressure protection of system (reserved)	Hardware malfunction	E3

# 9. Maintenance

Compressor overload protection	Viewing malfunction code through remote controller within 200s; displayed directly on nixietube after 200s	H3
Indoor unit and outdoor unit do not match	Hardware malfunction	LP
Malfunction of memory chip	Hardware malfunction	EE
Wrong connection of communication wire or malfunction of electronic expansion valve	Hardware malfunction	dn
Malfunction of complete units current detection	Hardware malfunction	U5
Malfunction protection of outdoor fan 1	Hardware malfunction	L3
Detection status of wrong connection of communication wire or malfunction of electronic expansion valve	Operation status	dd
Mode conflict	Operation status	E7
Refrigerant recycling mode	Operation status	Fo
X-fan	Operation status	AL
Defrosting or oil return in heating mode	Operation status	H1
Start failure of compressor	Viewing malfunction code through remote controller within 200s; displayed directly on nixietube after 200s	Lc
High discharge temperature protection of compressor		E4
Overload protection		E8
Whole unit overcurrent protection		E5
Compressor phase current protection		P5
Compressor desynchronizing		H7
Compressor phase-lacking/phase-inverse protection		Ld
IPM modular protection		H5
DC bus-bar low voltage protection		PL
DC bus-bar high voltage protection		PH
PFC protection		HC
The four-way valve is abnormal		U7

## 9.3 Malfunction Checking and Elimination

1 IPM protection malfunction:

Main checking point:

- If the input voltage of the unit is within normal range?
- If the connection wire of compressor is connected well? Is it loose? If the connection sequence is correct?
- If the resistance of compressor coil is normal? If the isolation of compressor coil with copper pipe is good?
- If the unit is overloaded? If the heat radiation of the unit is good?
- If the refrigerant charge is suitable?

Flow chart:

# 9. Maintenance

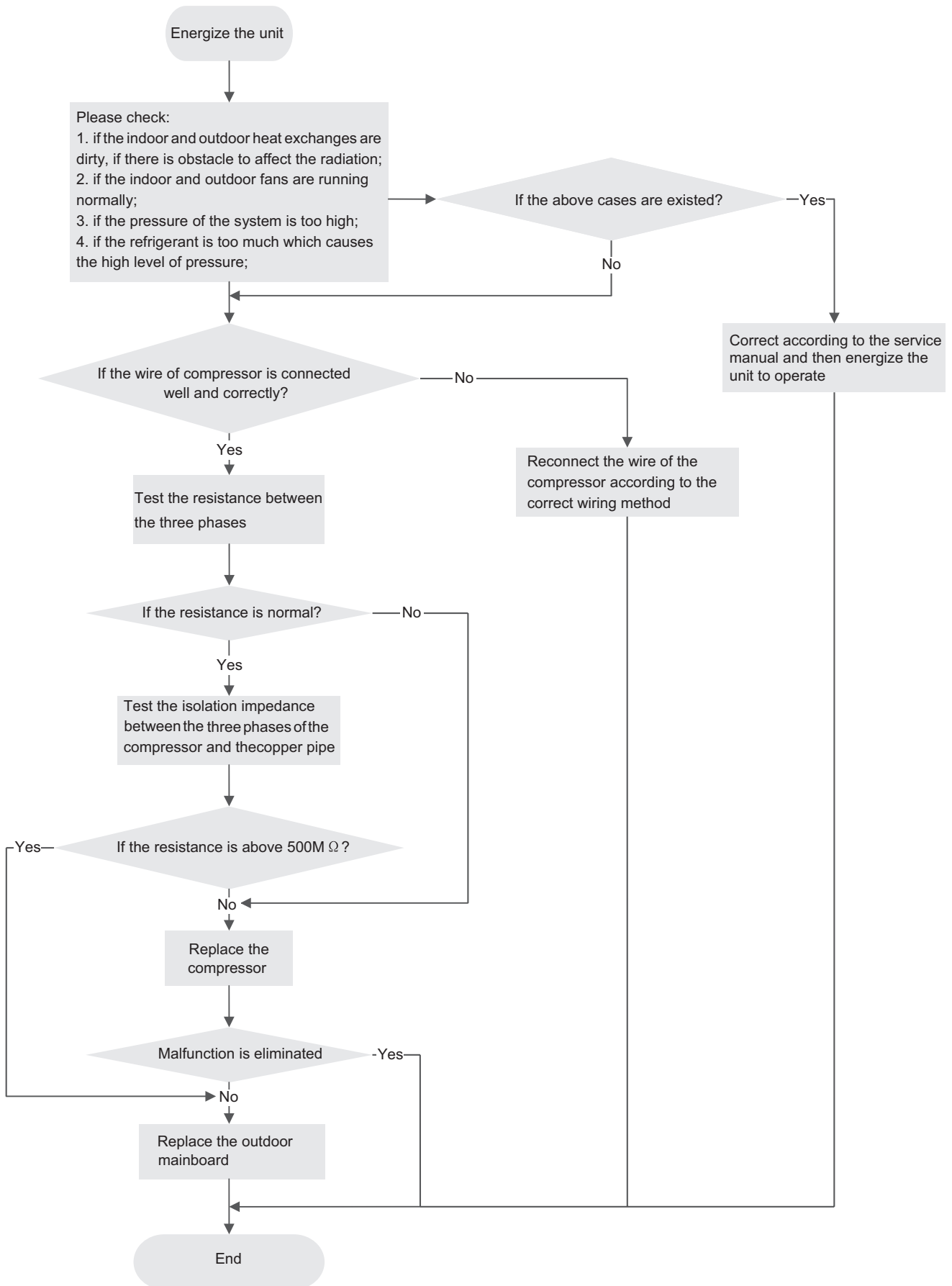

# 9. Maintenance

2. PFC protection malfunction, capacity charging malfunction

Main checking points:

- If the wiring of the induction is connected well and if the induction is broken;
- If the mainboard is broken;

Flow chart:

For 14/18K

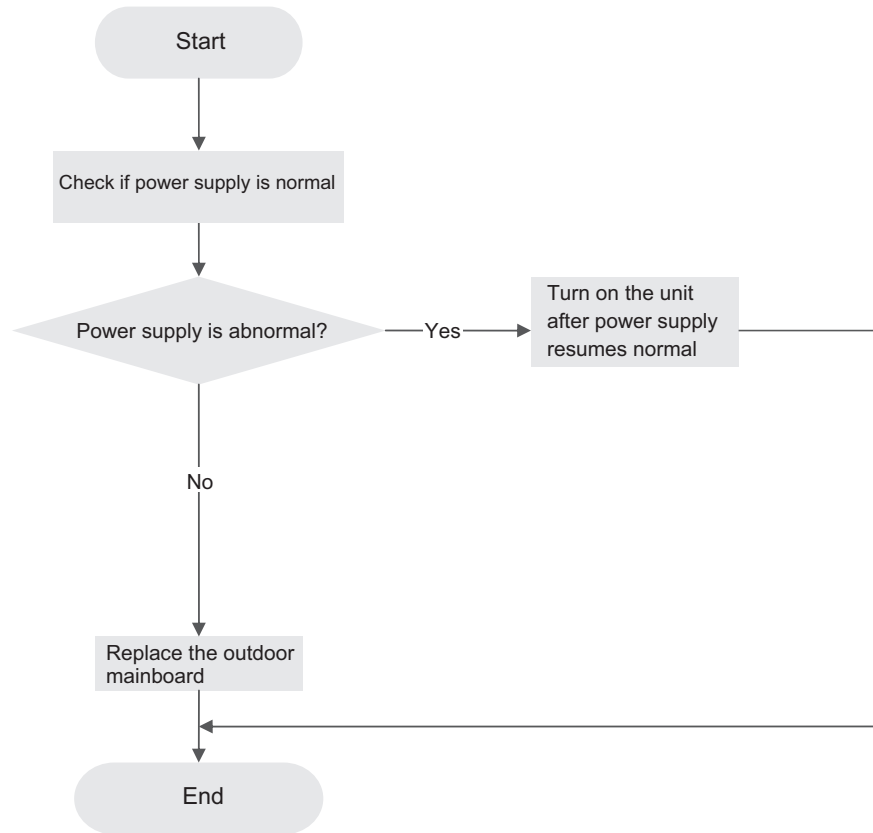

# 9. Maintenance

## 3. Compressor desynchronizing malfunction

Main checking points:

- If the pressure of the system is too high;
- If the electric expansion valve is working normally or it is broken;
- If the radiation of the unit is good;

Flow chart:

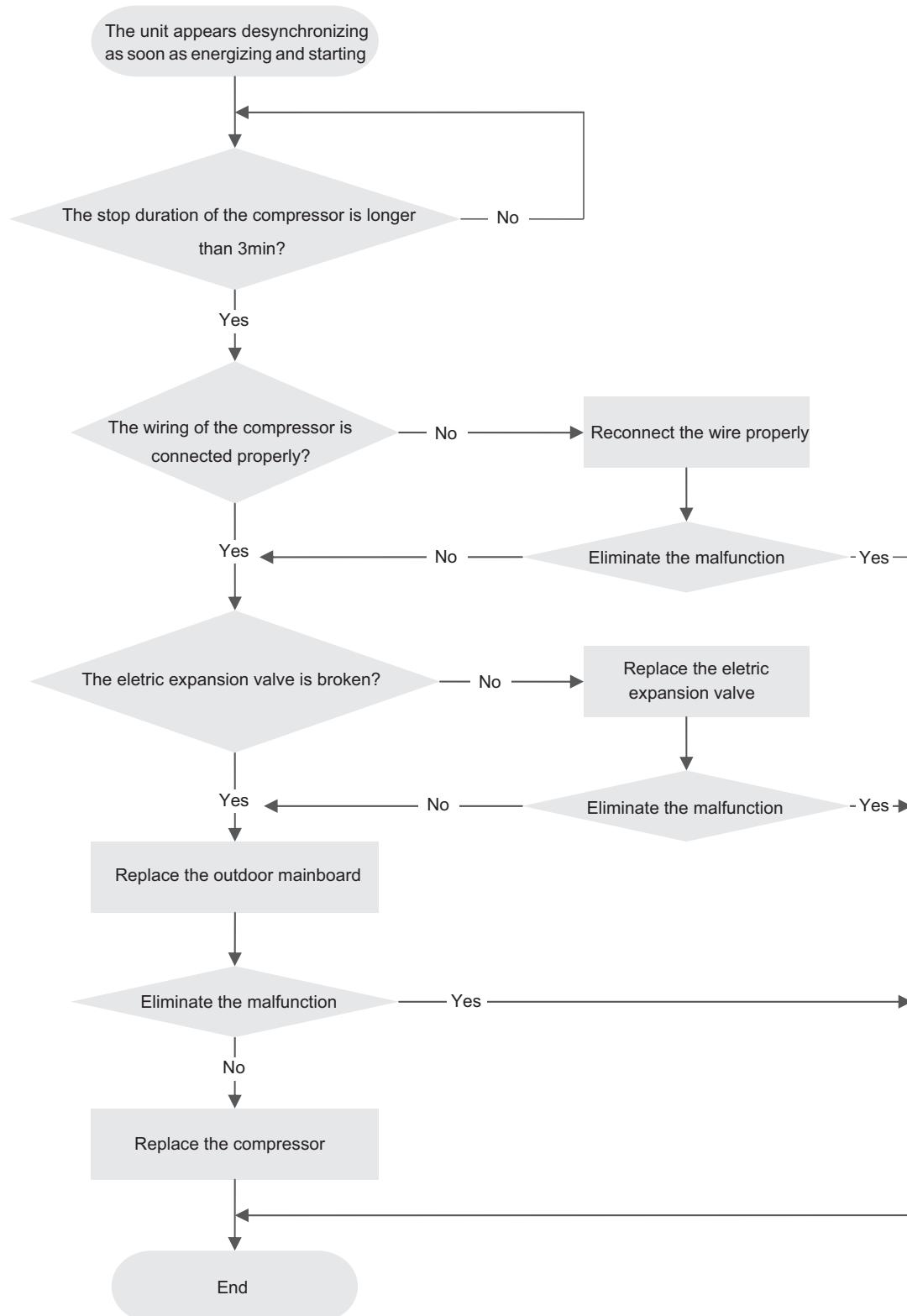

# 9. Maintenance

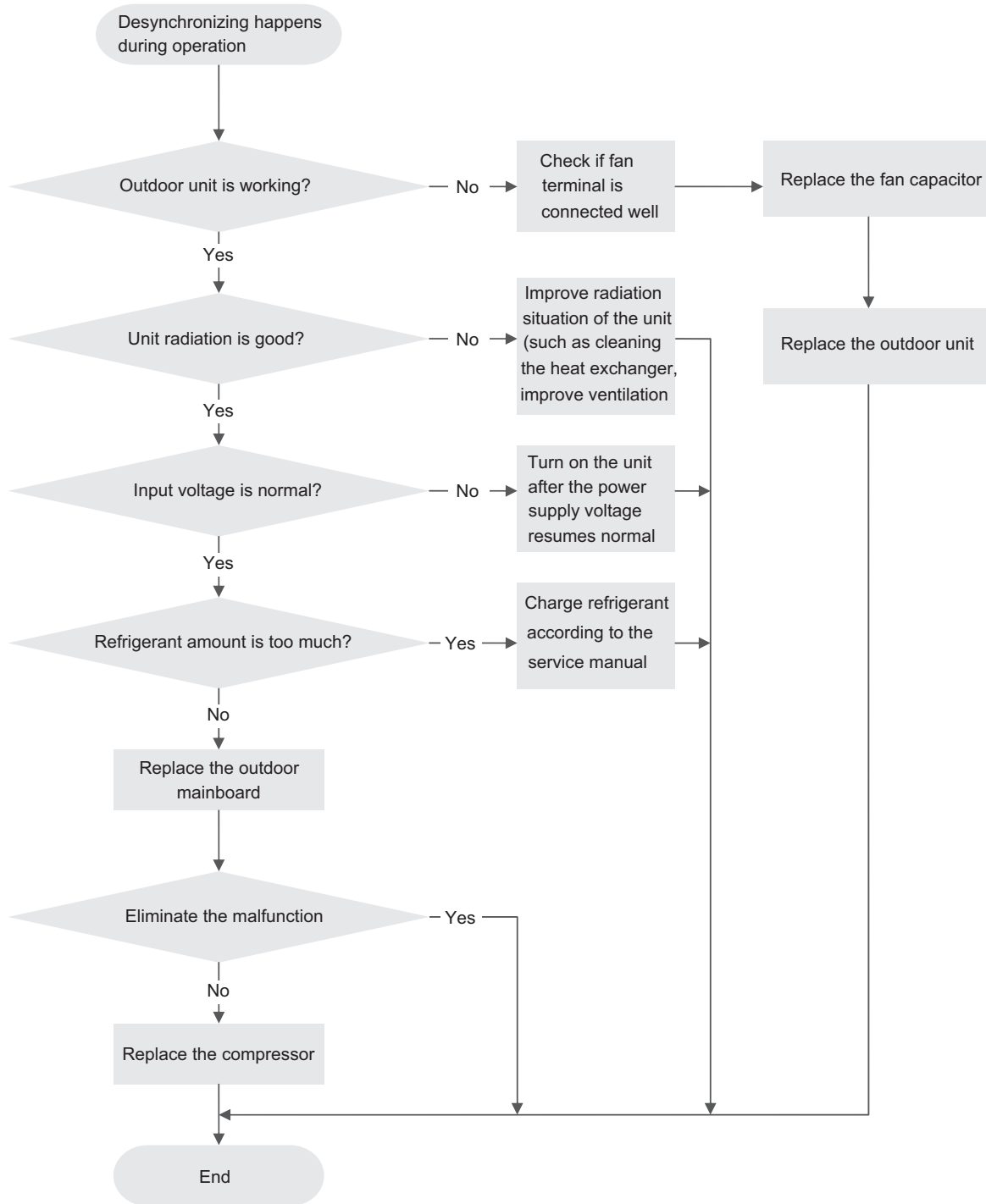



# 9. Maintenance

## 4. Compressor overload, discharge protection malfunction

Main checking points:

- If the electric expansion valve is connected well or it is broken;
- If there is refrigerant leakage;
- If the overload protector is broken;

Flow chart:

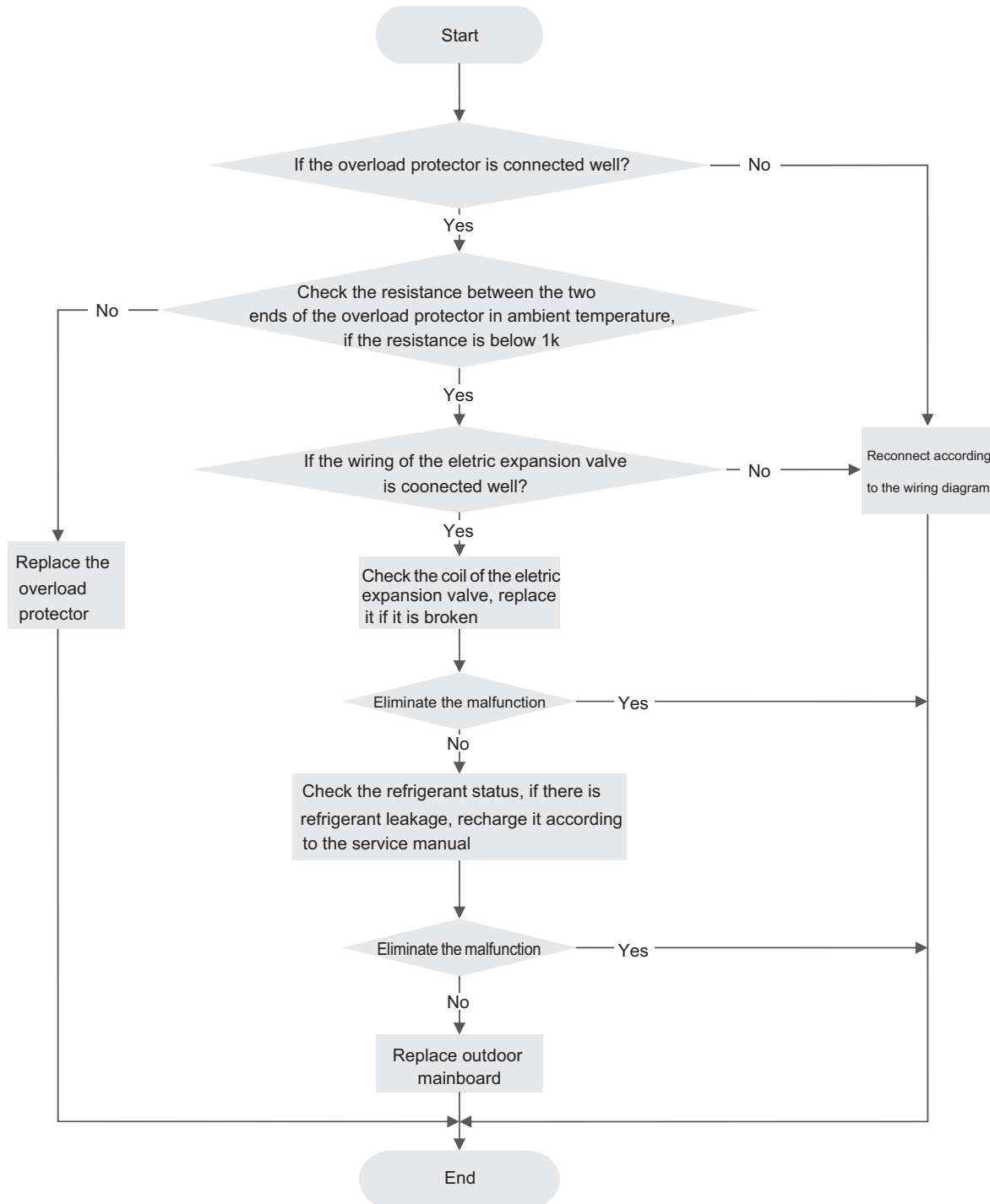

Note: the detection method of the coil of the electric expansion valve: there is five pieces of coil of the electric expansion valve, the resistance of one of them (the leftmost or the rightmost one) is almost the same as the resistance of other terminal (within  $100 \Omega$ ). Judge the condition of the electronic expansion valve through detecting these resistance.

# 9. Maintenance

## 5. Start failure/malfunction

Main checking points:

- If the connection wire of the compressor is connected properly;
- If the stop duration of the compressor is sufficient;
- If the compressor is broken;
- If the refrigerant charging amount is too much;

Flow chart:

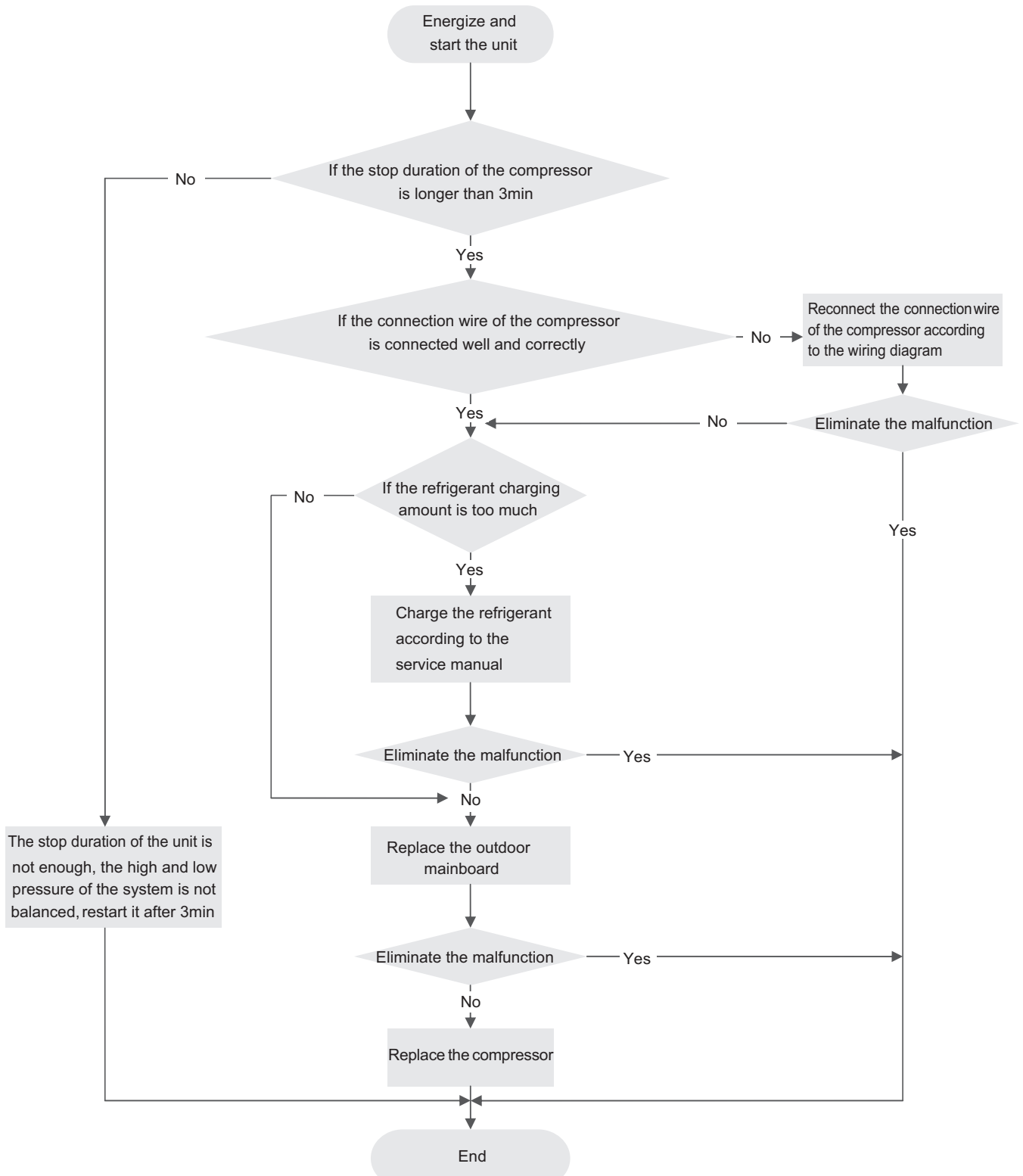

# 9. Maintenance

## 6. Temperature sensor malfunction

Main checking points:

- If the temperature sensor is damaged or broken
- If the terminal of the temperature sensor is loosened or not connected;
- If the mainboard is broken;

Flow chart:

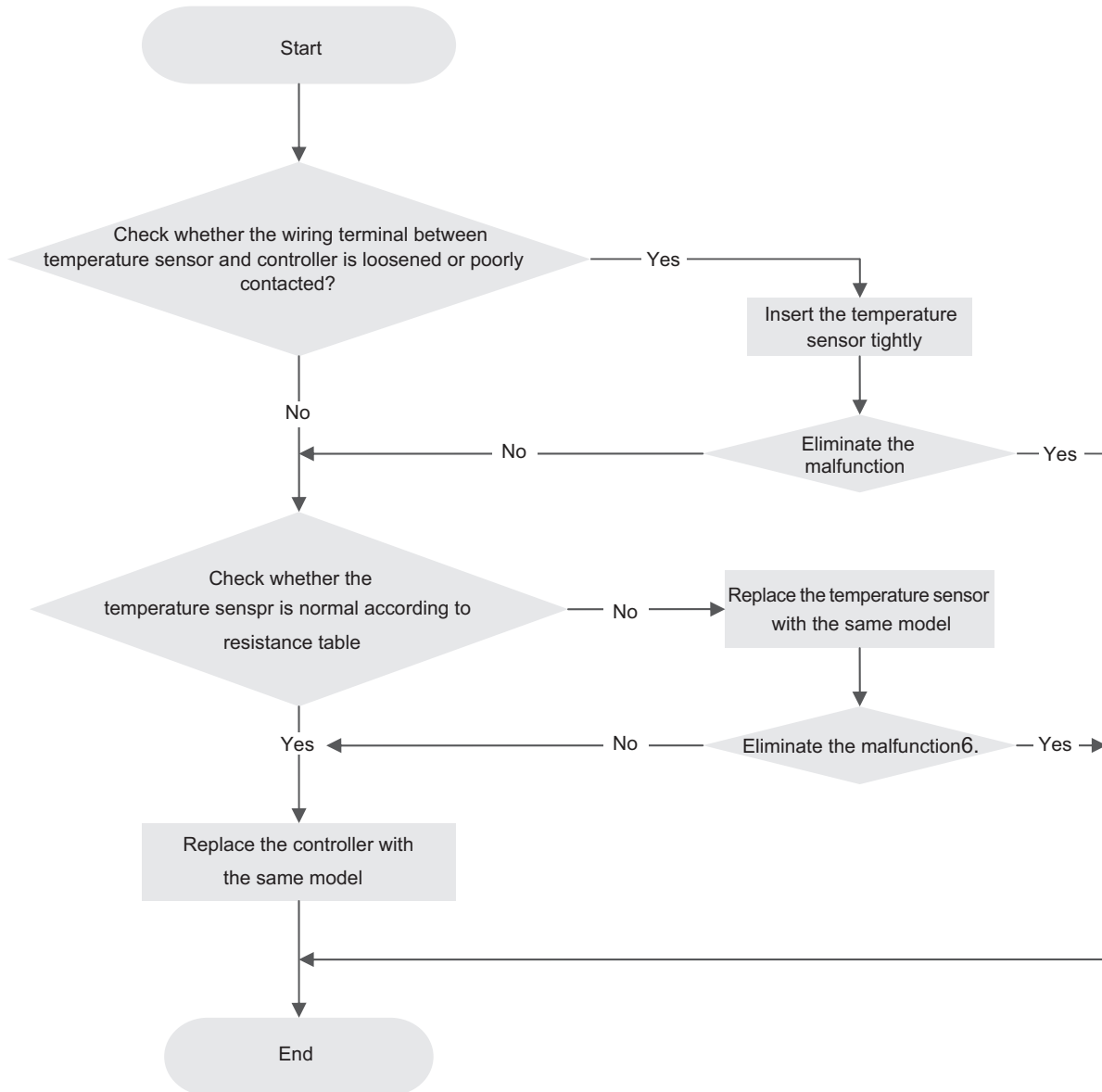

# 9. Maintenance

## 7. DC fan malfunction

Main checking points:

- If the outdoor fan is blocked by foreign objects;
- The connection wire of DC fan is connected reliably? If it is loose?

Flow chart:

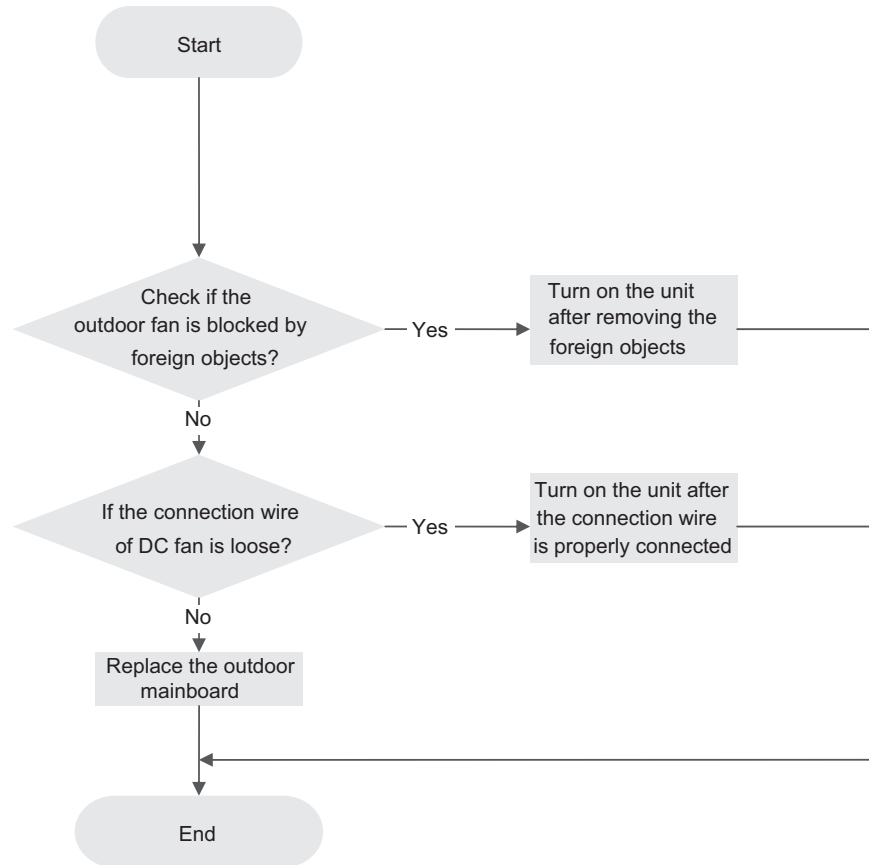

# 9. Maintenance

## 8. Communication malfunction

Main checking points:

- If the connection wire between the indoor unit and outdoor unit is connected well, if the wires inside the unit is connected well;
- If the indoor mainboard or outdoor main board is broken;

Flow chart:

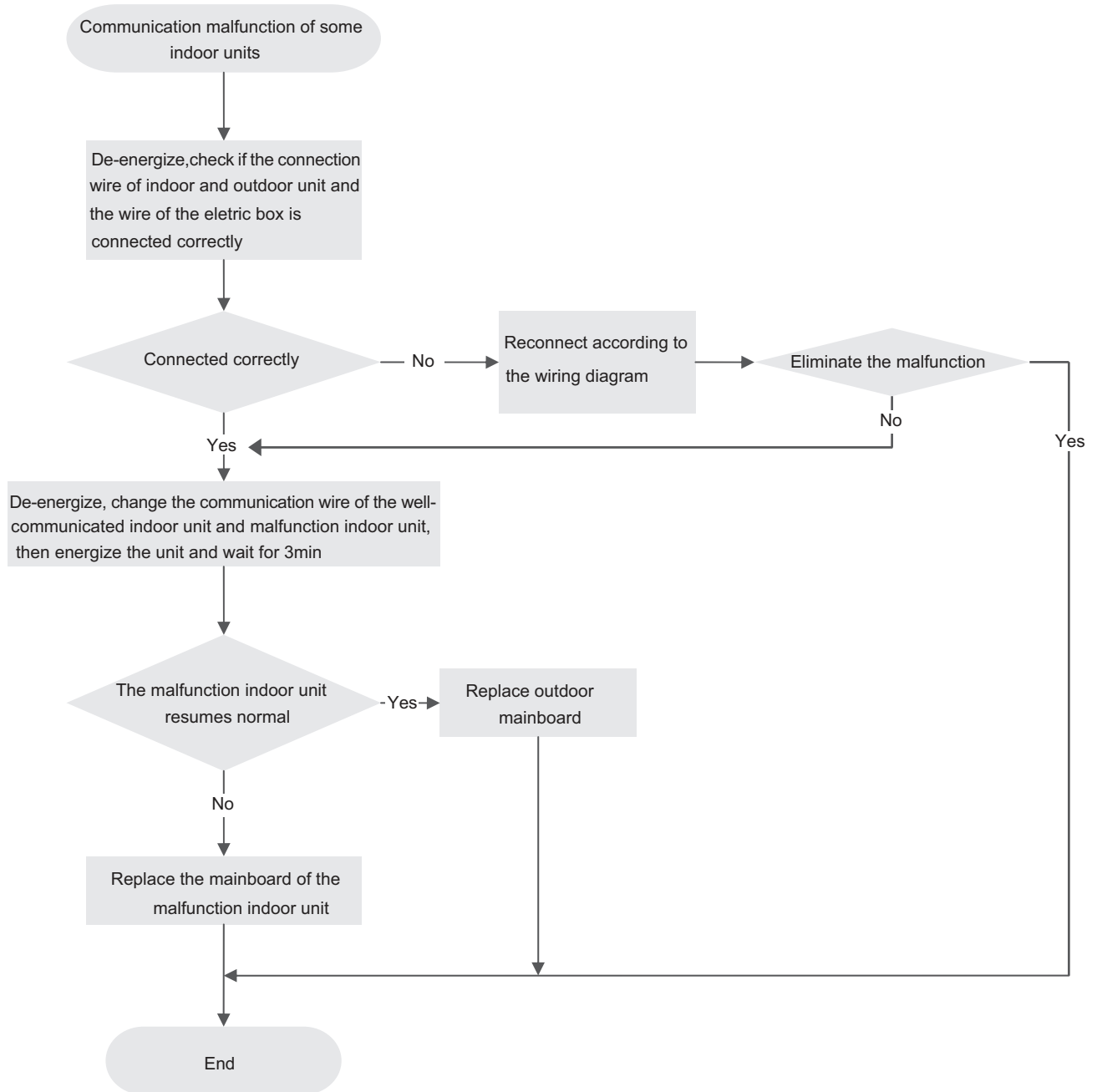

# 9. Maintenance

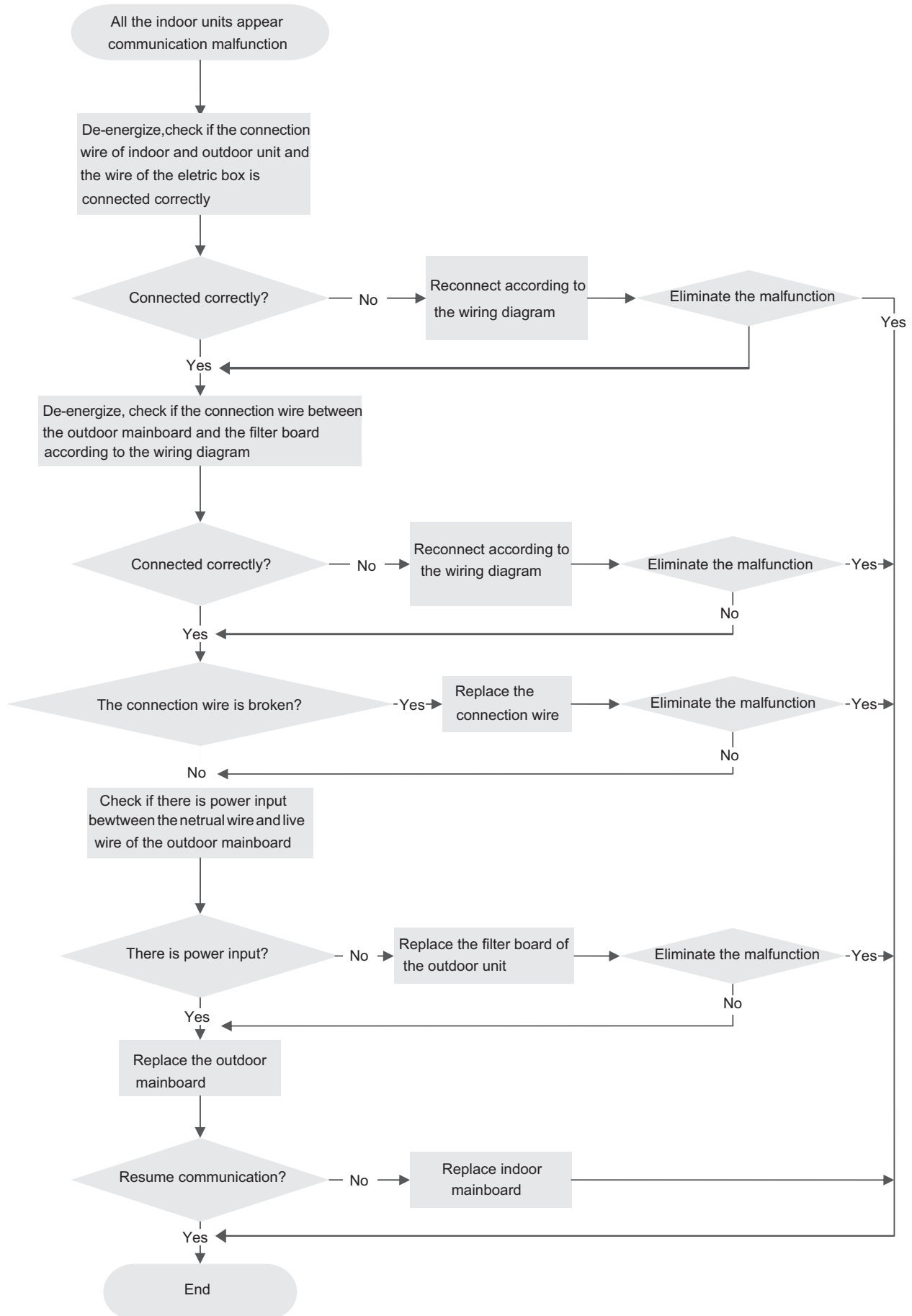

# 9. Maintenance

## 9. Anti-high temperature and overload malfunction

Main checking points:

- If the outdoor ambient temperature is within the normal range;
- If the indoor fan and outdoor fan are running normally;
- If the indoor and outdoor radiation environment is good;

Flow chart:

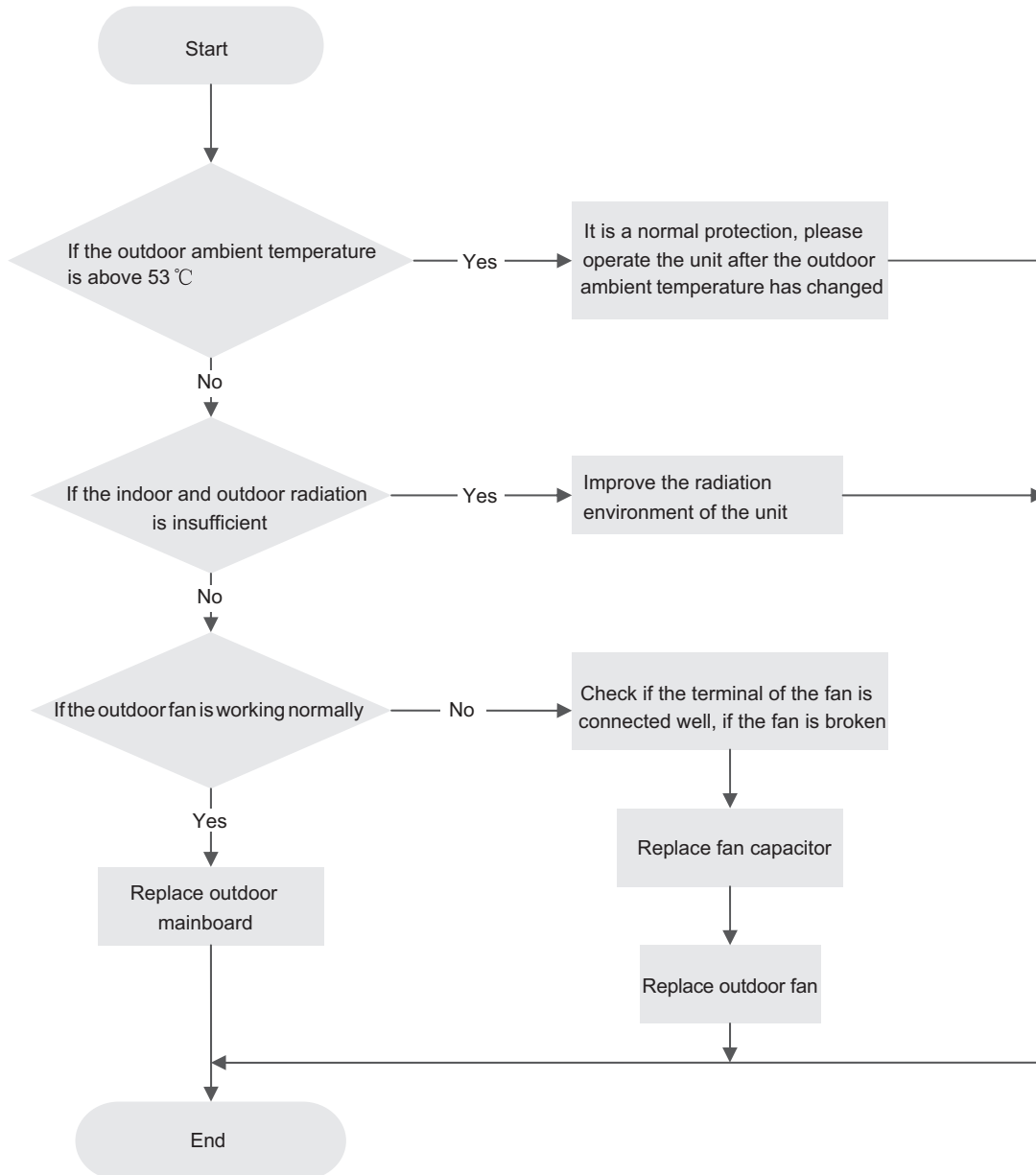

# 9. Maintenance

## 9.4 Troubleshooting for Normal Malfunction

### 1. Air Conditioner Can't be Started Up

Possible Causes	Discriminating Method (Air conditioner Status)	Troubleshooting
No power supply, or poor connection for power plug	After energization, operation indicator isn't bright and the buzzer can't give out sound	Confirm whether its due to power failure. If yes, wait for power recovery. If not, check power supply circuit and make sure the power plug is connected well.
Wrong wire connection between indoor unit and outdoor unit, or poor connection for wiring terminals	Under normal power supply circumstances, operation indicator isn't bright after energization	Check the circuit according to circuit diagram and connect wires correctly. Make sure all wiring terminals are connected firmly
Electric leakage for air conditioner	After energization, room circuit breaker trips off at once	Make sure the air conditioner is grounded reliably Make sure wires of air conditioner is connected correctly Check the wiring inside air conditioner. Check whether the insulation layer of power cord is damaged; if yes, place the power cord.
Model selection for air switch is improper	After energization, air switch trips off	Select proper air switch
Malfunction of remote controller	After energization, operation indicator is bright, while no display on remote controller or buttons have no action.	Replace batteries for remote controller Repair or replace remote controller

### 2. Poor Cooling (Heating) for Air Conditioner

Possible Causes	Discriminating Method (Air conditioner Status)	Troubleshooting
Set temperature is improper	Observe the set temperature on remote controller	Adjust the set temperature
Rotation speed of the IDU fan motor is set too low	Small wind blow	Set the fan speed at high or medium
Filter of indoor unit is blocked	Check the filter to see its blocked	Clean the filter
Installation position for indoor unit and outdoor unit is improper	Check whether the installation position is proper according to installation requirement for air conditioner	Adjust the installation position, and install the rainproof and sunproof for outdoor unit
Refrigerant is leaking	Discharged air temperature during cooling is higher than normal discharged wind temperature; Discharged air temperature during heating is lower than normal discharged wind temperature; Units pressure is much lower than regulated range	Find out the leakage causes and deal with it. Add refrigerant.
Malfunction of 4-way valve	Blow cold wind during heating	Replace the 4-way valve
Malfunction of capillary	Discharged air temperature during cooling is higher than normal discharged wind temperature; Discharged air temperature during heating is lower than normal discharged wind temperature; Unit pressure is much lower than regulated range. If refrigerant isn't leaking, part of capillary is blocked	Replace the capillary
Flow volume of valve is insufficient	The pressure of valves is much lower than that stated in the specification	Open the valve completely
Malfunction of horizontal louver	Horizontal louver can't swing	Refer to point 3 of maintenance method for details
Malfunction of the IDU fan motor	The IDU fan motor can't operate	Refer to troubleshooting for H6 for maintenance method in details
Malfunction of the ODU fan motor	The ODU fan motor can't operate	Refer to point 4 of maintenance method for details
Malfunction of compressor	Compressor can't operate	Refer to point 5 of maintenance method for details

### 3. Horizontal Louver Can't Swing

Possible Causes	Discriminating Method (Air conditioner Status)	Troubleshooting
Wrong wire connection, or poor connection	Check the wiring status according to circuit diagram	Connect wires according to wiring diagram to make sure all wiring terminals are connected firmly
Stepping motor is damaged	Stepping motor can't operate	Repair or replace stepping motor
Main board is damaged	Others are all normal, while horizontal louver can't operate	Replace the main board with the same model



# 9. Maintenance

## 4. ODU Fan Motor Can't Operate

Possible causes	Discriminating method (air conditioner status)	Troubleshooting
Wrong wire connection, or poor connection	Check the wiring status according to circuit diagram	Connect wires according to wiring diagram to make sure all wiring terminals are connected firmly
Capacity of the ODU fan motor is damaged	Measure the capacity of fan capacitor with an universal meter and find that the capacity is out of the deviation range indicated on the nameplate of fan capacitor.	Replace the capacity of fan
Power voltage is a little low or high	Use universal meter to measure the power supply voltage. The voltage is a little high or low	Suggest to equip with voltage regulator
Motor of outdoor unit is damaged	When unit is on, cooling/heating performance is bad and ODU compressor generates a lot of noise and heat.	Change compressor oil and refrigerant. If no better, replace the compressor with a new one

## 5. Compressor Can't Operate

Possible causes	Discriminating method (air conditioner status)	Troubleshooting
Wrong wire connection, or poor connection	Check the wiring status according to circuit diagram	Connect wires according to wiring diagram to make sure all wiring terminals are connected firmly
Capacity of compressor is damaged	Measure the capacity of fan capacitor with an universal meter and find that the capacity is out of the deviation range indicated on the nameplate of fan capacitor.	Replace the compressor capacitor
Power voltage is a little low or high	Use universal meter to measure the power supply voltage. The voltage is a little high or low	Suggest to equip with voltage regulator
Coil of compressor is burnt out	Use universal meter to measure the resistance between compressor terminals and its 0	Repair or replace compressor
Cylinder of compressor is blocked	Compressor can't operate	Repair or replace compressor

## 6. Air Conditioner is Leaking

Possible causes	Discriminating method (air conditioner status)	Troubleshooting
Drain pipe is blocked	Water leaking from indoor unit	Eliminate the foreign objects inside the drain pipe
Drain pipe is broken	Water leaking from drain pipe	Replace drain pipe
Wrapping is not tight	Water leaking from the pipe connection place of indoor unit	Wrap it again and bundle it tightly

## 7. Abnormal Sound and Vibration

Possible causes	Discriminating method (air conditioner status)	Troubleshooting
When turn on or turn off the unit, the panel and other parts will expand and theres abnormal sound	Theres the sound of "PAPA"	Normal phenomenon. Abnormal sound will disappear after a few minutes.
When turn on or turn off the unit, theres abnormal sound due to flow of refrigerant inside air conditioner	Water-running sound can be heard	Normal phenomenon. Abnormal sound will disappear after a few minutes.
Foreign objects inside the indoor unit or therere parts touching together inside the indoor unit	Theres abnormal sound fro indoor unit	Remove foreign objects. Adjust all parts position of indoor unit, tighten screws and stick damping plaster between connected parts
Foreign objects inside the outdoor unit or therere parts touching together inside the outdoor unit	Theres abnormal sound fro outdoor unit	Remove foreign objects. Adjust all parts position of outdoor unit, tighten screws and stick damping plaster between connected parts
Short circuit inside the magnetic coil	During heating, the way valve has abnormal electromagnetic sound	Replace magnetic coil
Abnormal shake of compressor	Outdoor unit gives out abnormal sound	Adjust the support foot mat of compressor, tighten the bolts
Abnormal sound inside the compressor	Abnormal sound inside the compressor	If add too much refrigerant during maintenance, please reduce refrigerant properly. Replace compressor for other circumstances.

# 10. Exploded View and Parts List

CHML-U14RK2-NG  
CHML-U18RK2-NG

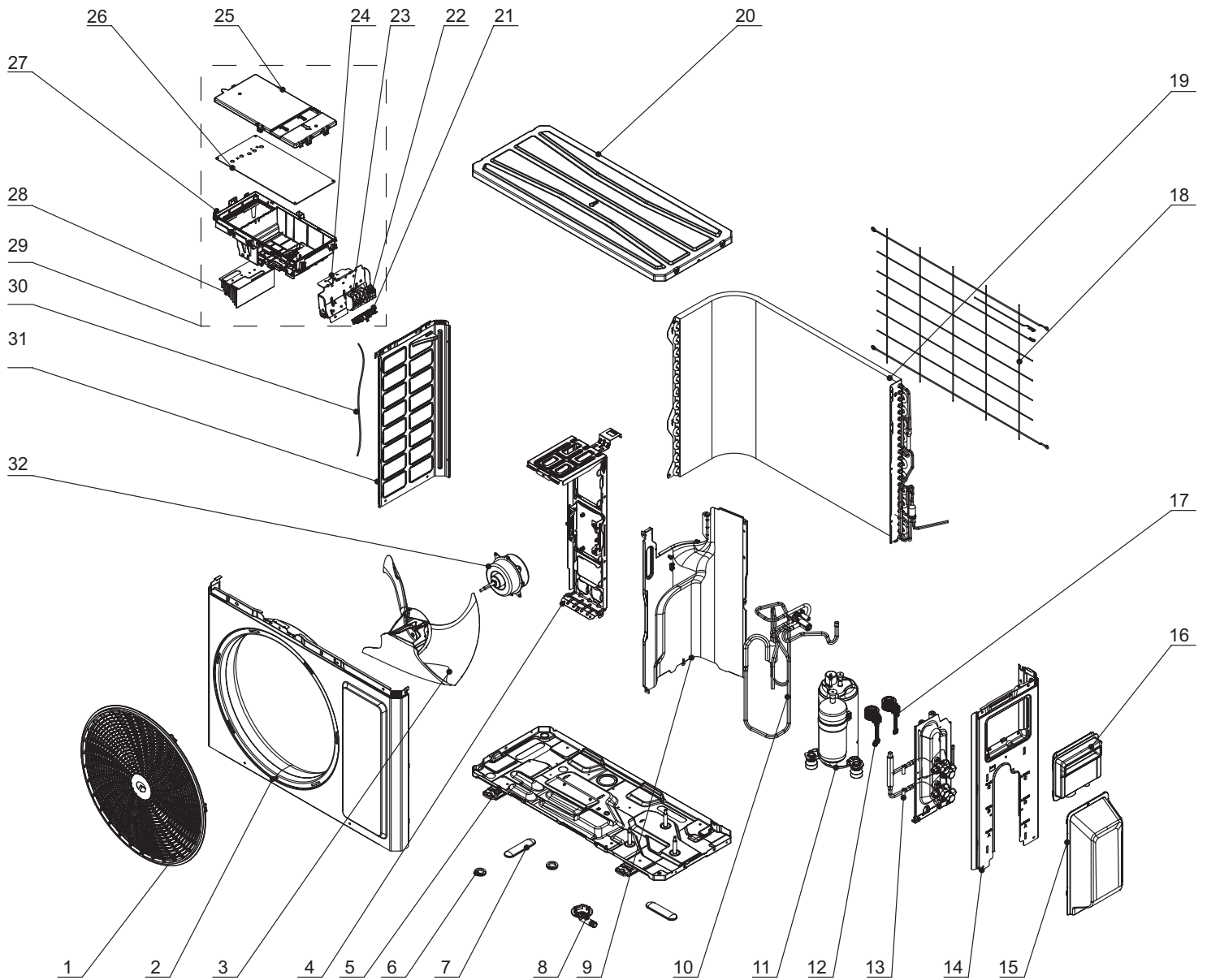

The component is only for reference; please refer to the actual product.

NO.	Description
1	Front Grill
2	Cabinet Assy
3	Axial Flow Fan
4	Motor Support Sub-Assy
5	Chassis Sub-assy
6	Drainage hole Cap
7	Drainage hole Cap
8	Drainage Connector
9	Clapboard
10	4-Way Valve Assy
11	Compressor and Fittings

NO.	Description
12	Electric Expansion Valve Coil
13	Valve Support Assy
14	Right Side Plate
15	Valve Cover
16	Cable Cross Plate
17	Electric Expansion Valve Coil
18	Rear Grill
19	Condenser Assy
20	Top Cover Plate Assy
21	Wire Clamp
22	Terminal Board

NO.	Description
23	Terminal Board
24	Terminal Board Support Assy
25	Electric Box cover
26	Main Board
27	Electric Box
28	Radiator
29	Electric Box Assy
30	Connecting Cable
31	Left Side Plate
32	Fan Motor

Some models may not contain some parts, please refer to the actual product.

# 10. Exploded View and Parts List

CHML-U21RK3-NG  
CHML-U24RK3-NG

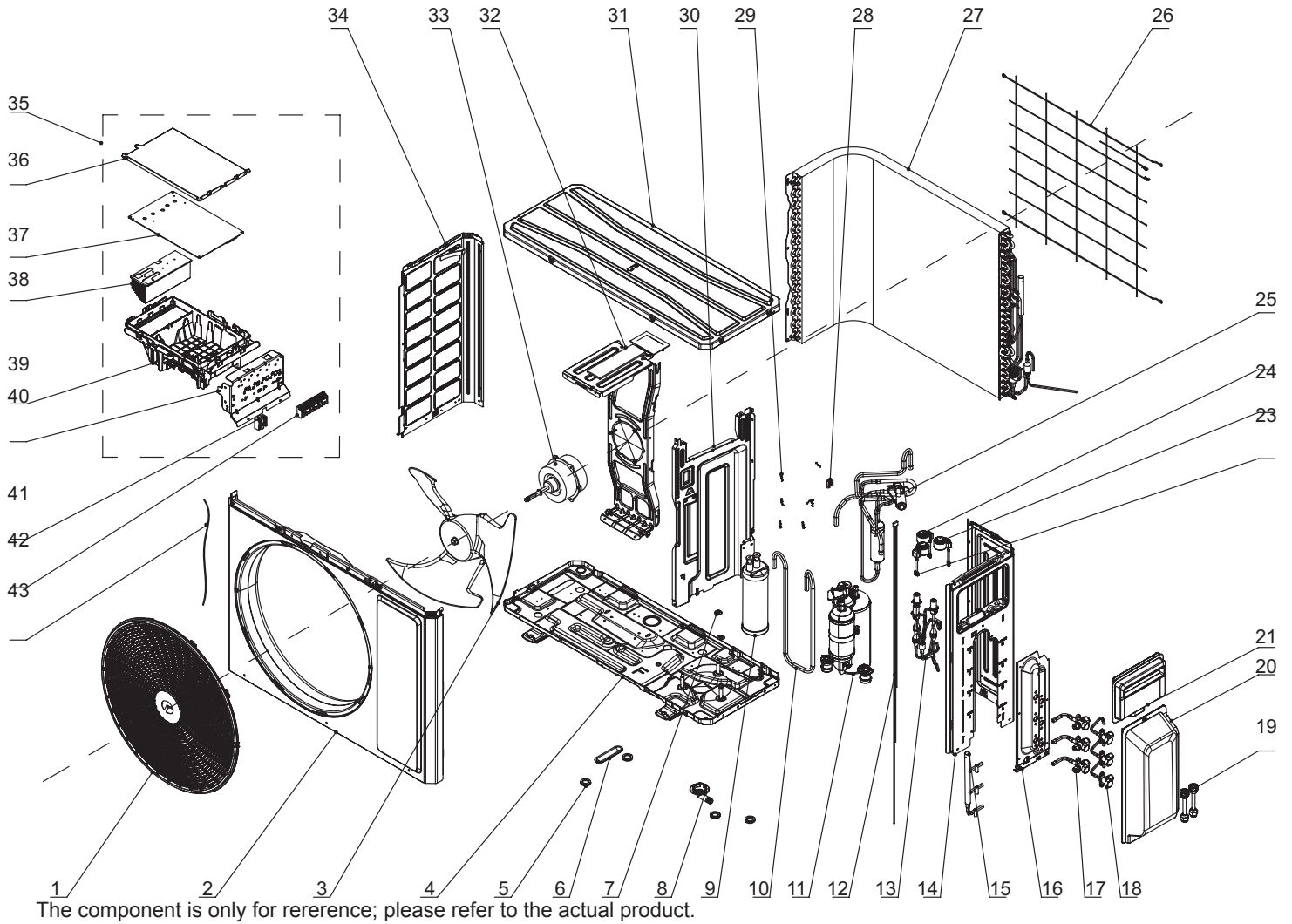

The component is only for reference; please refer to the actual product.

NO.	Description
1	Front Grill 2 Front Panel
3	Axial Flow Fan
4	Chassis Sub-assy
5	Drainage hole
6	Cap
7	Compressor
8	Gasket
9	Drainage Joint
10	Gas-liquid Separator
11	Inhalation Tube
12	Compressor and Fittings
13	Temperature Sensor
14	Electronic Expansion Valve Assy
15	Right Side Plate
16	Gas Separator Sub-assy

NO.	Description
16	Valve Support Assy
17	Cut-off valve Sub-assy
18	Cut-off valve Sub-assy
19	Tube Connector Sub-assy
20	Valve Cover
21	Cable Cross Plate
22	Electric Expansion Valve Coil
23	Electric Expansion Valve Coil
24	Electric Expansion Valve Coil
25	4-Way Valve Assy
26	Rear Grill
27	Condenser Assy
28	Sensor Clamp
29	Sensor Insert
30	Clapboard Sub-assy

NO.	Description
31	Top Cover Plate Assy
32	Motor Support Sub-Assy
33	Fan Motor
34	Left Side Plate
35	Electric Box Assy
36	Electric Box Cover
37	Main Board
38	Radiator
39	Electric Box
40	Terminal Board Support Assy
41	Terminal Board
42	Terminal Board
43	Connecting Cable

Some models may not contain some parts, please refer to the actual product.

# 10. Exploded View and Parts List

CHML-U28RK4-NG

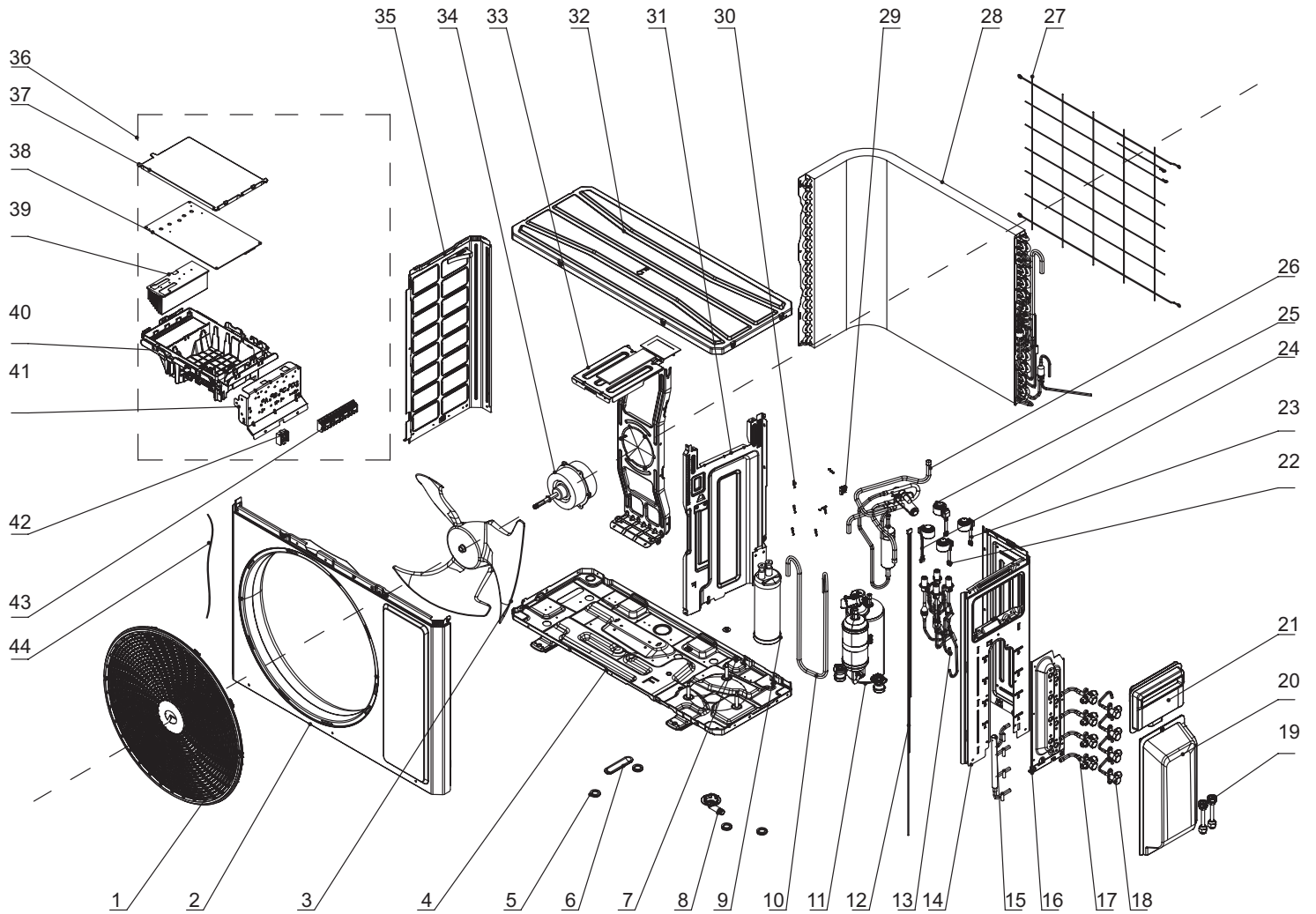

The component is only for reference; please refer to the actual product.

NO.	Description	NO.	Description	NO.	Description
1	Front Grill 2 Front Panel 3 Axial Flow Fan 4 Chassis Sub-assy 5 Drainage hole Cap 6 Drainage hole Cap 7 Compressor Gasket 8 Drainage Joint 9 Gas-liquid Separator 10 Inhalation Tube 11 Compressor and Fittings 12 Temperature Sensor 13 Electronic Expansion Valve Assy 14 Right Side Plate 15 Gas Separator Sub-assy	16	Valve Support Assy	31	Clapboard Sub-assy
		17	Cut-off valve Sub-assy	32	Top Cover Plate Assy
		18	Cut-off valve Sub-assy	33	Motor Support Sub-Assy
		19	Tube Connector Sub-assy	34	Fan Motor
		20	Valve Cover	35	Left Side Plate
		21	Cable Cross Plate	36	Electric Box Assy
		22	Electric Expansion Valve Coil	37	Electric Box Cover
		23	Electric Expansion Valve Coil	38	Main Board
		24	Electric Expansion Valve Coil	39	Radiator
		25	Electric Expansion Valve Coil	40	Electric Box
		26	4-Way Valve Assy	41	Terminal Board Support Assy
		27	Rear Grill	42	Terminal Board
		28	Condenser Assy	43	Terminal Board
		29	Sensor Clamp	44	Connecting Cable
		30	Sensor Insert		

Some models may not contain some parts, please refer to the actual product.

# 10. Exploded View and Parts List

CHML-U36RK4-NG

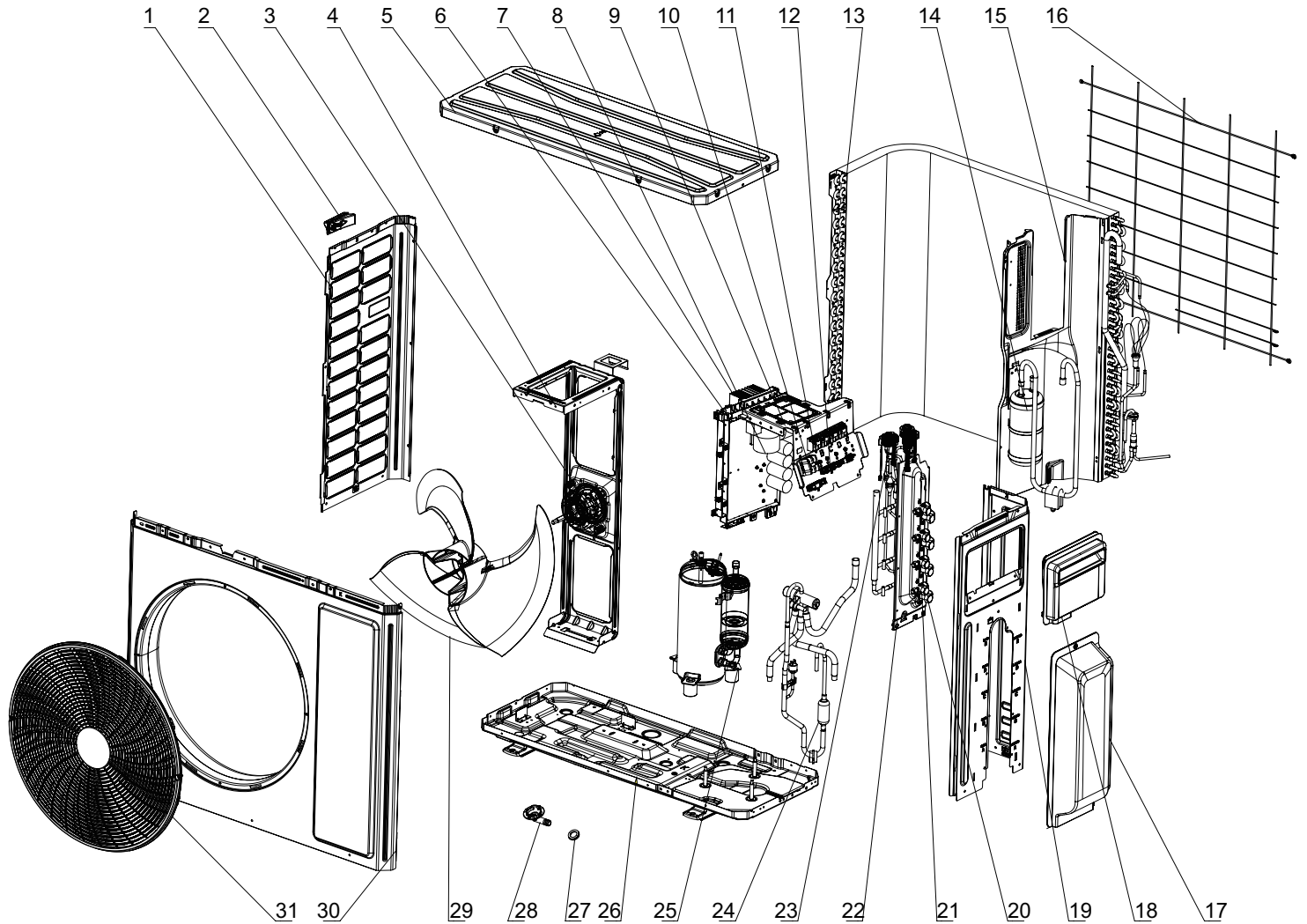

The component is only for reference; please refer to the actual product.

NO.	Description
1	Left Side Plate
2	Handle
3	Brushless DC Motor
4	Motor Support Sub-Assy
5	Top Cover Sub-Assy
	Electric Box Assy
7	Radiator
8	Main Board
9	Filter Board
10	Terminal Board
11	Terminal Board

NO.	Description
12	Wire Clamp
13	Condenser Assy
14	Gas-liquid Separator Assy
15	Clapboard
16	Rear Grill
17	Valve Cover
18	Handle
19	Right Side Plate
20	Cut off Valve Sub-Assy(1/4)
21	Cut off Valve Sub-Assy(3/8)
22	Valve Support Sub-Assy

NO.	Description
23	Electronic Expansion Valve assy
24	4-Way Valve Assy
25	Compressor and Fittings
26	Chassis Sub-assy
27	Drainage hole Cap
28	Drainage Joint
29	Axial Flow Fan
30	Cabinet
31	Front Grill

Some models may not contain some parts, please refer to the actual product.



# 10. Exploded View and Parts List

CHML-U42RK5-NG

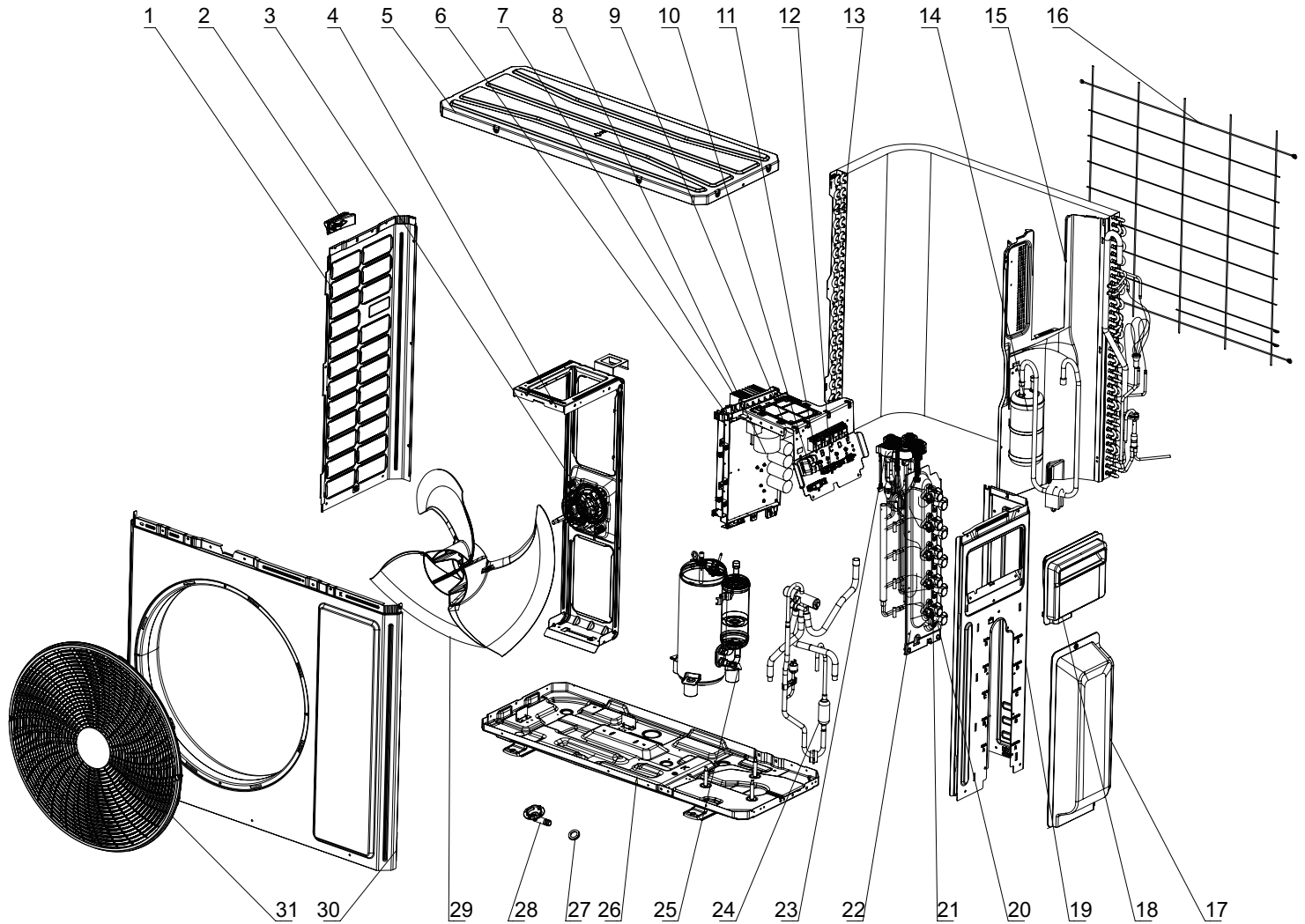

The component is only for reference; please refer to the actual product.

NO.	Description
1	Left Side Plate
2	Handle
3	Brushless DC Motor
4	Motor Support Sub-Assy
5	Top Cover Sub-Assy
	Electric Box Assy
7	Radiator
8	Main Board
9	Filter Board
10	Terminal Board
11	Terminal Board

NO.	Description
12	Wire Clamp
13	Condenser Assy
14	Gas-liquid Separator Assy
15	Clapboard
16	Rear Grill
17	Valve Cover
18	Handle
19	Right Side Plate
20	Cut off Valve Sub-Assy(1/4)
21	Cut off Valve Sub-Assy(3/8)
22	Valve Support Sub-Assy



NO.	Description
23	Electronic Expansion Valve assy
24	4-Way Valve Assy
25	Compressor and Fittings
26	Chassis Sub-assy
27	Drainage hole Cap
28	Drainage Joint
29	Axial Flow Fan
30	Cabinet
31	Front Grill

Some models may not contain some parts, please refer to the actual product.



# 11. Removal Procedure

CHML-U14RK2-NG  
CHML-U18RK2-NG

 **Warning:** Be sure to wait for a minimum of 20 minutes after turning off all power supplies and discharge the refrigerant completely before removal.

Step	Procedure
<b>1. Before disassembly</b>	 <p>Complete axonometric drawing.</p>
<b>2. Remove valve cover</b>	 <p>Remove the connection screw fixing the valve cover and then remove the valve cover.</p> <p>valve cover</p>
<b>3. Remove handle</b>	 <p>Remove the connection screws fixing the handle and the right side plate, and then remove the handle.</p> <p>Handle</p>

# 11. Removal Procedure

Step	Procedure
<b>4. Remove top panel</b>	<p>Remove the connection screws connecting the top panel and the front panel, and then remove the top panel.</p> 
<b>5. Remove front grille</b>	<p>Remove the connection screws connecting the front grille and the front panel, and then loosen the clasp to remove the front grille.</p> 
<b>6. Remove front panel</b>	<p>Remove the screws connecting the front panel and then remove the front panel.</p> 

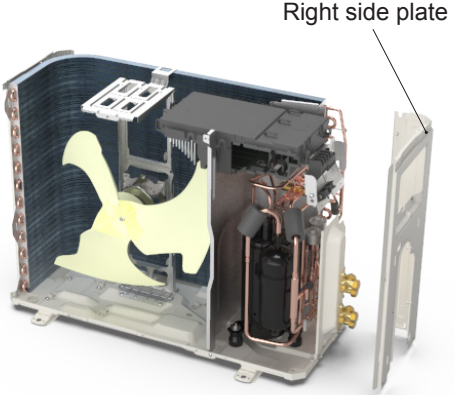
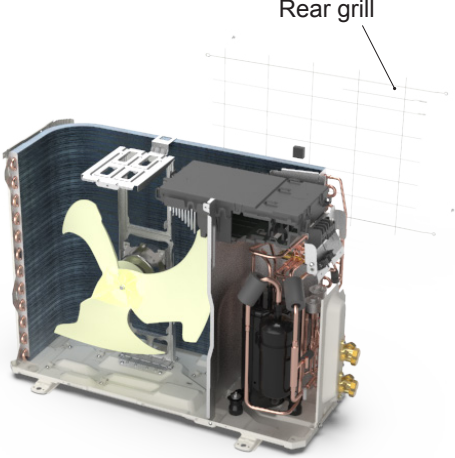
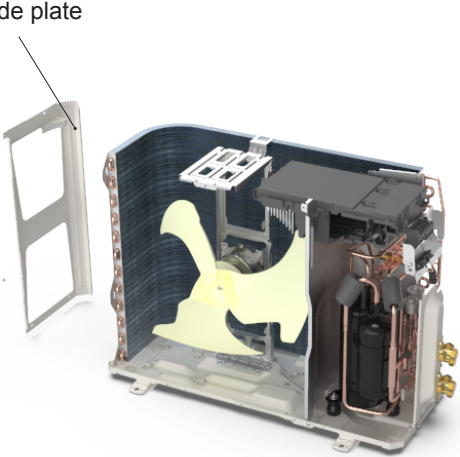

# 11. Removal Procedure

Step	Procedure
<b>7. Remove right side plate</b>	<p>Remove the screws connecting the right side plate with the chassis and the valve support. Then remove the right side plate.</p>  <p>Right side plate</p>
<b>8. Remove rear grill</b>	<p>Remove the screws connecting the rear grill and left side plate, and then remove the rear grill.</p>  <p>Rear grill</p>
<b>9. Remove left side plate</b>	<p>Remove the screws fixing the left side plate with the chassis and the condenser support, and then remove the left side plate.</p>  <p>Left side plate</p>

# 11. Removal Procedure

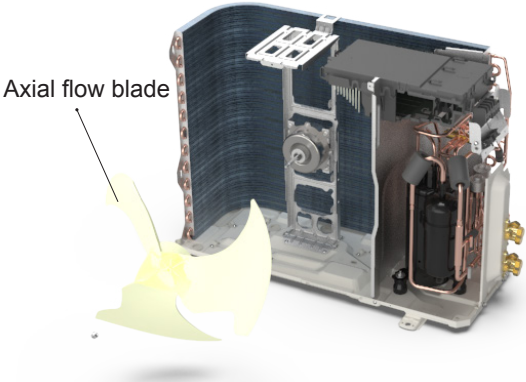
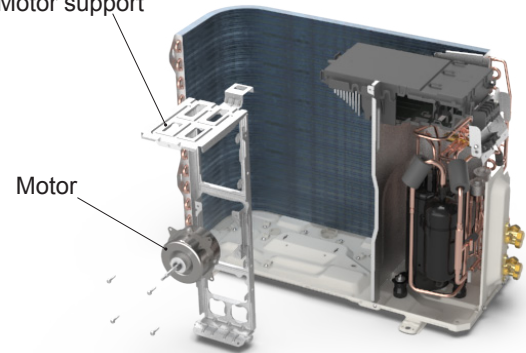
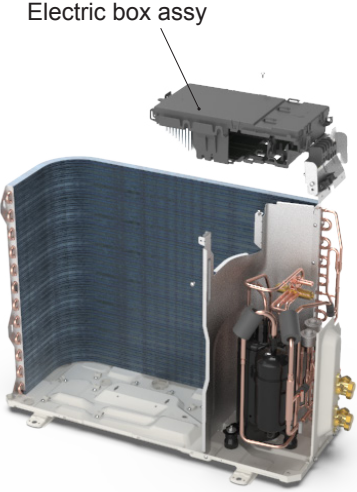
Step	Procedure
<b>10. Remove axial flow blade</b>	<p>Remove the nut on the blade and then remove the axial flow blade.</p> 
<b>11. Remove motor and motor support</b>	<p>Remove the 4 tapping screws fixing the motor and disconnect the leading wire insert of the motor. Then remove the motor. Remove the 2 tapping screws fixing the motor support and chassis, and then lift the motor support to remove it.</p> 
<b>12. Remove electric box assy</b>	<p>Remove the screws fixing the electric box assy and the middle isolation sheet, loosen the wire bundle, unplug the wiring terminals, and then lift the electric box assy to remove it.</p> 

# 11. Removal Procedure

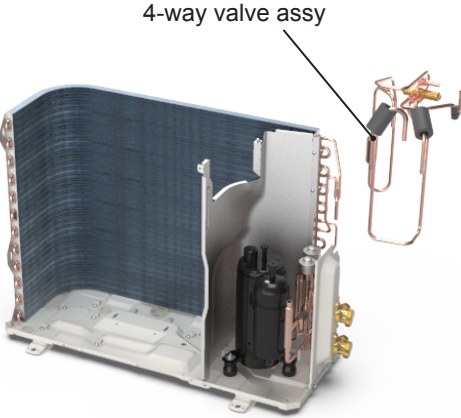
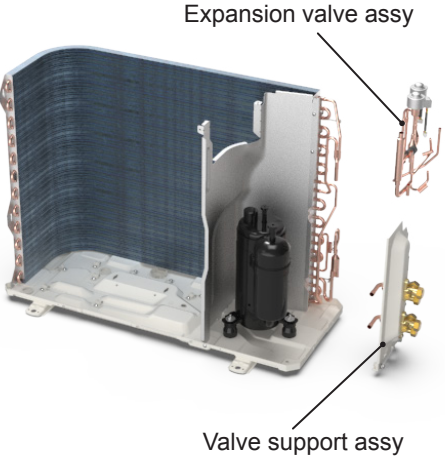
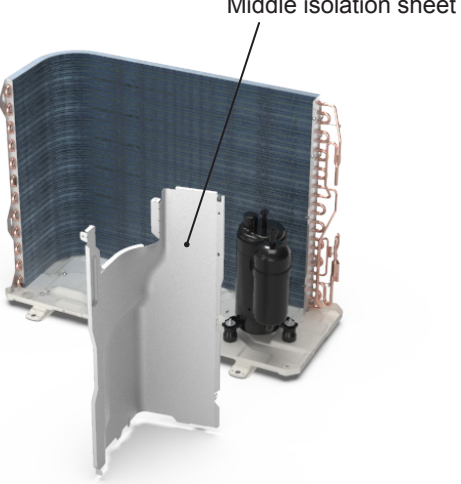
Step	Procedure
<b>13. Remove 4-way valve assy</b>	<p>Remove screws fixing the electricbox; loosen the wire bundle; pull out the wiring terminals and then pull electric box upwards to remove it.</p>  <p>4-way valve assy</p>
<b>14. Remove valve support sub-assy and expansion valve assy</b>	<p>Remove the screw connecting the valve support and the chassis, and then remove the valve support assy. Unsolder the welding joint connecting the electronic expansion valve assy with the cut-off valve and the condenser connection pipe, and then remove the expansion valve assy.</p>  <p>Expansion valve assy</p> <p>Valve support assy</p>
<b>15. Remove middle isolation sheet</b>	<p>Remove the screws connecting the middle isolation sheet with the chassis assy and the condenser assy, and then remove the middle isolation sheet.</p>  <p>Middle isolation sheet</p>

# 11. Removal Procedure

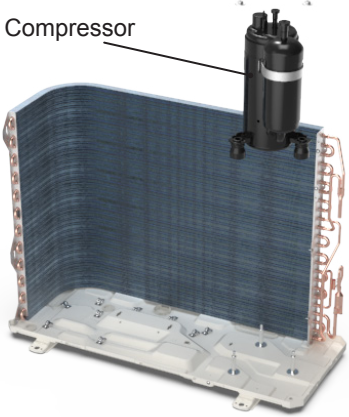
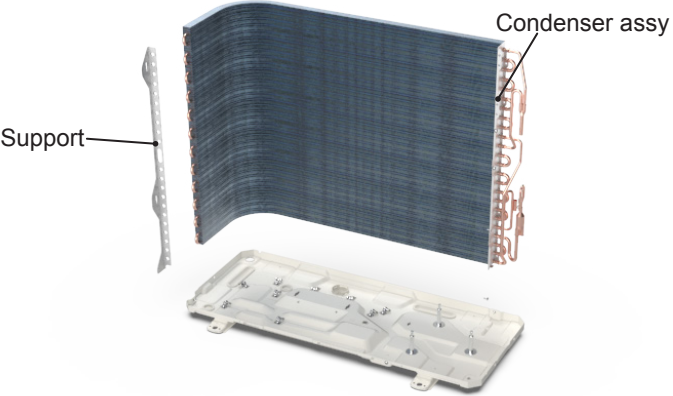

Step	Procedure
<b>16. Remove compressor</b>	 <p>Remove the 3 foot nuts fixing the compressor and then remove the compressor.</p>
<b>17. Remove condenser assy</b>	 <p>Remove the screws fixing the condenser support and then remove the condenser support. Remove the screws connecting the condenser support and the chassis assy, and then remove the condenser assy.</p>

# 11. Removal Procedure

CHML-U21RK3-NG  
CHML-U24RK3-NG



**Warning:** Be sure to wait for a minimum of 20 minutes after turning off all power supplies and discharge the refrigerant completely before removal.

Step	Procedure
<b>1. Before disassembly</b>	 <p>Complete axonometric drawing.</p>
<b>2. Remove valve cover</b>	 <p>Remove the connection screw fixing the valve cover and then remove the valve cover.</p> <p>valve cover</p>
<b>3. Remove handle</b>	 <p>Remove the connection screws fixing the handle and the right side plate, and then remove the handle.</p> <p>Handle</p>

# 11. Removal Procedure

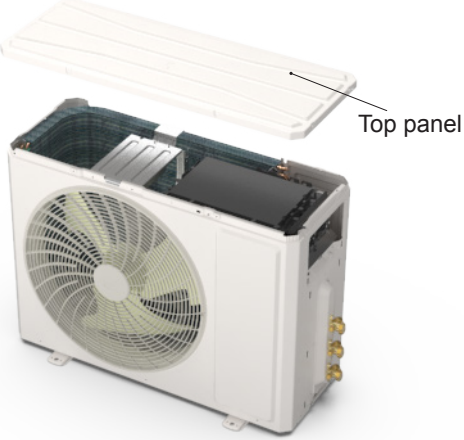
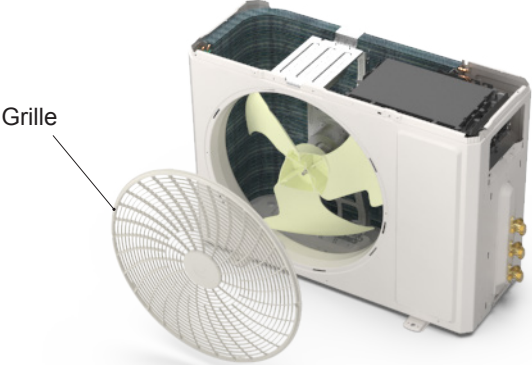
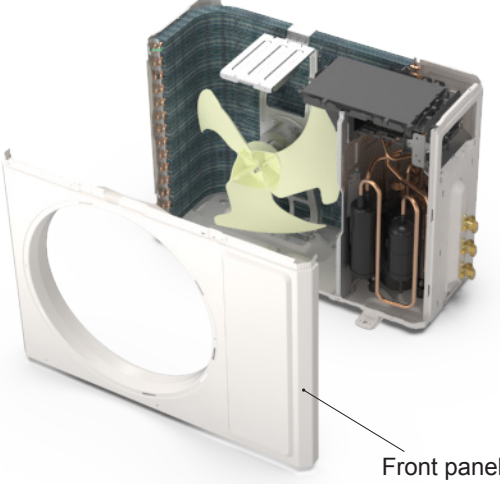
Step	Procedure
<b>4. Remove top panel</b>	<p>Remove the connection screws connecting the top panel and the front panel, and then remove the top panel.</p> 
<b>5. Remove front grille</b>	<p>Remove the connection screws connecting the front grille and the front panel, and then loosen the clasp to remove the front grille.</p> 
<b>6. Remove front panel</b>	<p>Remove the screws connecting the front panel and then remove the front panel.</p> 

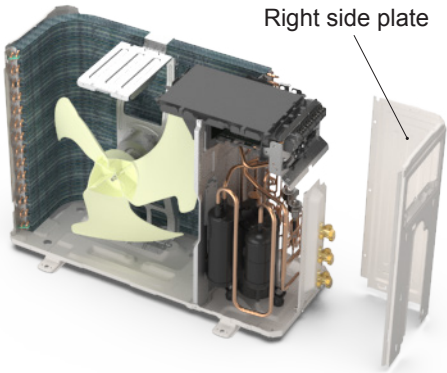
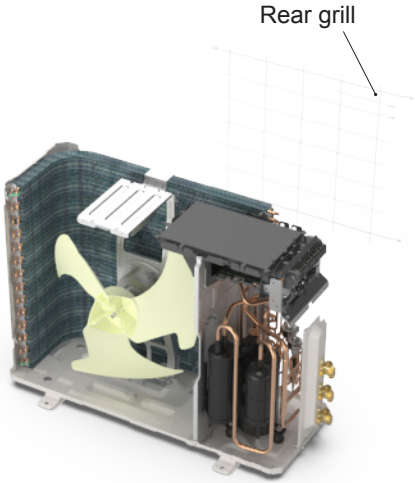
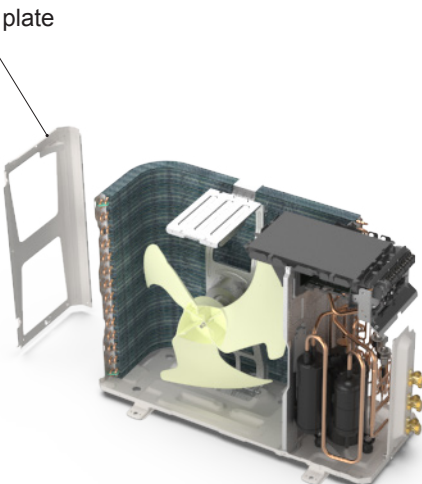

# 11. Removal Procedure

Step	Procedure
<b>7. Remove right side plate</b>	<p>Remove the screws connecting the right side plate with the chassis and the valve support. Then remove the right side plate.</p>  <p>Right side plate</p>
<b>8. Remove rear grill</b>	<p>Remove the screws connecting the rear grill and left side plate, and then remove the rear grill.</p>  <p>Rear grill</p>
<b>9. Remove left side plate</b>	<p>Remove the screws fixing the left side plate with the chassis and the condenser support, and then remove the left side plate.</p>  <p>Left side plate</p>

# 11. Removal Procedure

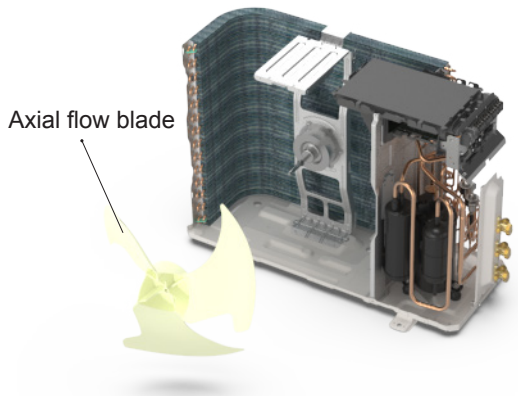
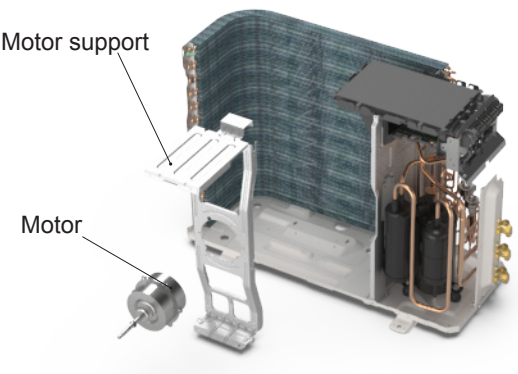
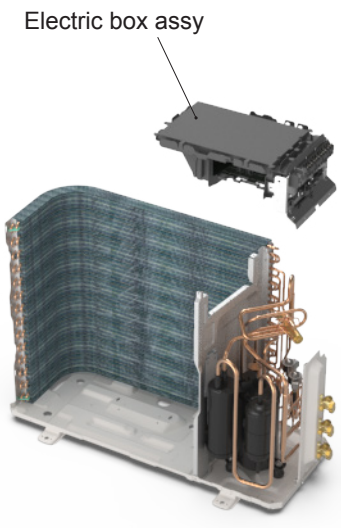
Step	Procedure
<b>10. Remove axial flow blade</b>	<p>Remove the nut on the blade and then remove the axial flow blade.</p>  <p>Axial flow blade</p>
<b>11. Remove motor and motor support</b>	<p>Remove the 4 tapping screws fixing the motor and disconnect the leading wire insert of the motor. Then remove the motor. Remove the 2 tapping screws fixing the motor support and chassis, and then lift the motor support to remove it.</p>  <p>Motor support</p> <p>Motor</p>
<b>12. Remove electric box assy</b>	<p>Remove the screws fixing the electric box assy and the middle isolation sheet, loosen the wire bundle, unplug the wiring terminals, and then lift the electric box assy to remove it.</p>  <p>Electric box assy</p>

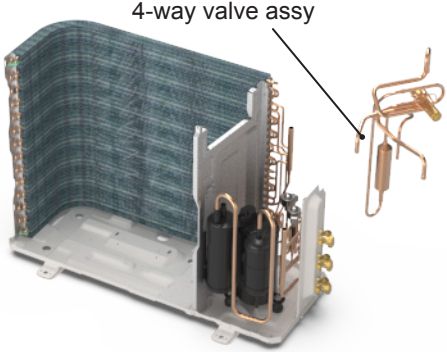
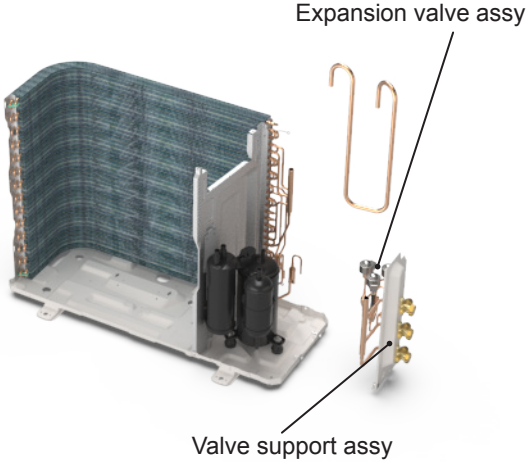
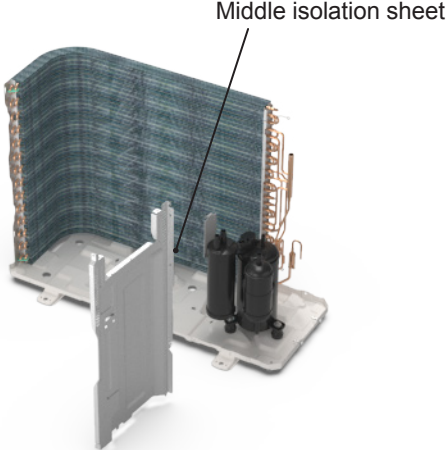

# 11. Removal Procedure

Step	Procedure
<b>13. Remove 4-way valve assy</b>	<p>Remove screws fixing the electricbox; loosen the wire bundle; pull out the wiring terminals and then pull electric box upwards to remove it.</p>  <p>4-way valve assy</p>
<b>14. Remove valve support sub-assy and expansion valve assy</b>	<p>Remove the screw connecting the valve support and the chassis, and then remove the valve support assy. Unsolder the welding joint connecting the electronic expansion valve assy with the cut-off valve and the condenser connection pipe, and then remove the expansion valve assy.</p>  <p>Expansion valve assy</p> <p>Valve support assy</p>
<b>15. Remove middle isolation sheet</b>	<p>Remove the screws connecting the middle isolation sheet with the chassis assy and the condenser assy, and then remove the middle isolation sheet.</p>  <p>Middle isolation sheet</p>

# 11. Removal Procedure

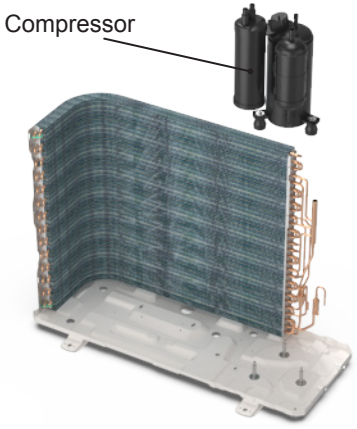
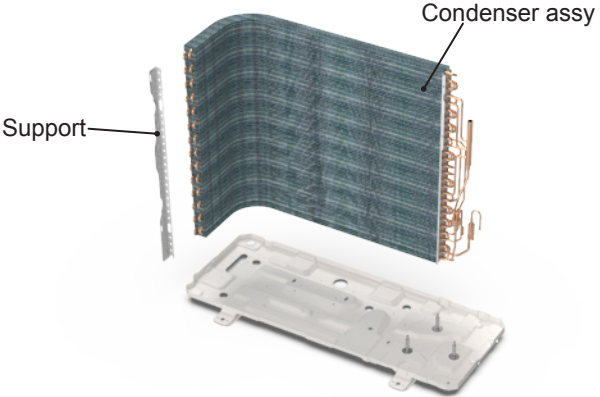

Step	Procedure
<b>16. Remove compressor</b>	<p>Remove the 3 foot nuts fixing the compressor and then remove the compressor.</p> 
<b>17. Remove condenser assy</b>	<p>Remove the screws fixing the condenser support and then remove the condenser support. Remove the screws connecting the condenser support and the chassis assy, and then remove the condenser assy.</p> 

# 11. Removal Procedure



CHML-U28RK4-NG



**Warning:** Be sure to wait for a minimum of 20 minutes after turning off all power supplies and discharge the refrigerant completely before removal.

Step	Procedure
<b>1. Before disassembly</b>	 <p>Complete axonometric drawing.</p>
<b>2. Remove valve cover</b>	 <p>Remove the connection screw fixing the valve cover and then remove the valve cover.</p> <p>valve cover</p>
<b>3. Remove handle</b>	 <p>Remove the connection screws fixing the handle and the right side plate, and then remove the handle.</p> <p>Handle</p>

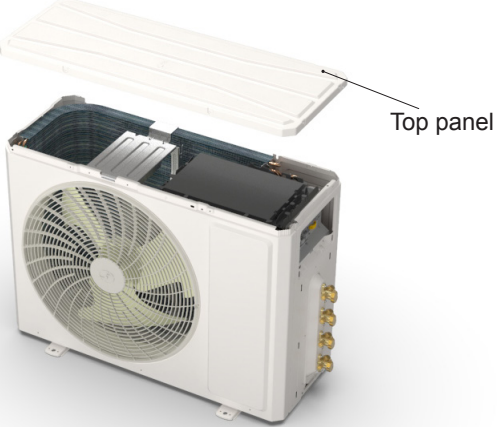
# 11. Removal Procedure

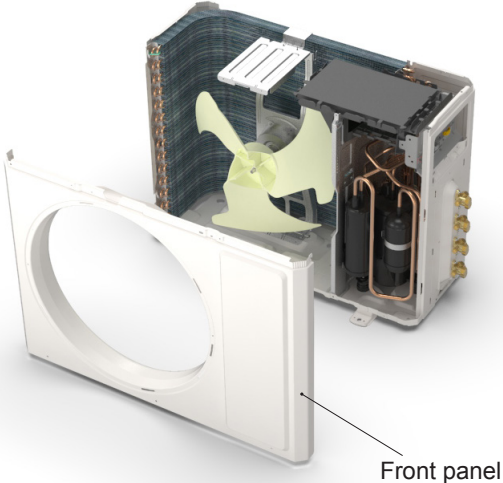
Step	Procedure
<b>4. Remove top panel</b>	<p>Remove the connection screws connecting the top panel and the front panel, and then remove the top panel.</p> 
<b>5. Remove front grille</b>	<p>Remove the connection screws connecting the front grille and the front panel, and then loosen the clasp to remove the front grille.</p> 
<b>6. Remove front panel</b>	<p>Remove the screws connecting the front panel and then remove the front panel.</p> 

# 11. Removal Procedure

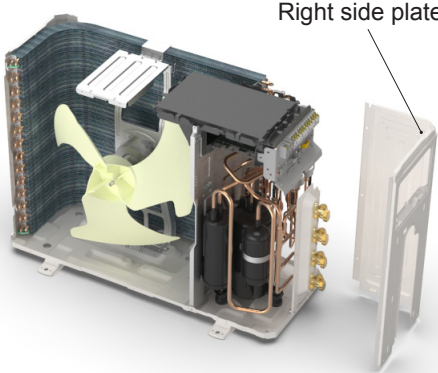
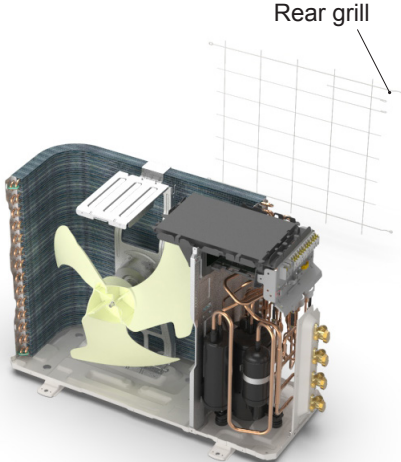
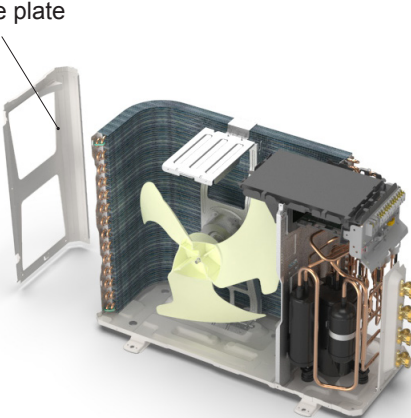
Step	Procedure
<b>7. Remove right side plate</b>	<p>Remove the screws connecting the right side plate with the chassis and the valve support. Then remove the right side plate.</p> 
<b>8. Remove rear grill</b>	<p>Remove the screws connecting the rear grill and left side plate, and then remove the rear grill.</p> 
<b>9. Remove left side plate</b>	<p>Remove the screws fixing the left side plate with the chassis and the condenser support, and then remove the left side plate.</p> 

# 11. Removal Procedure

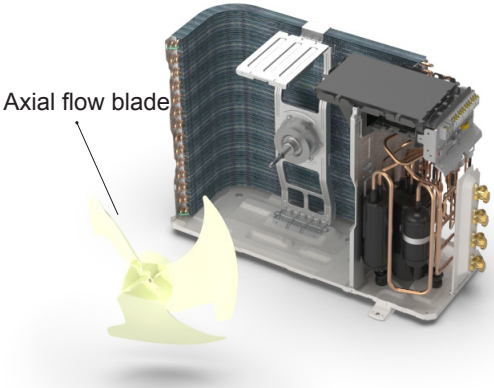
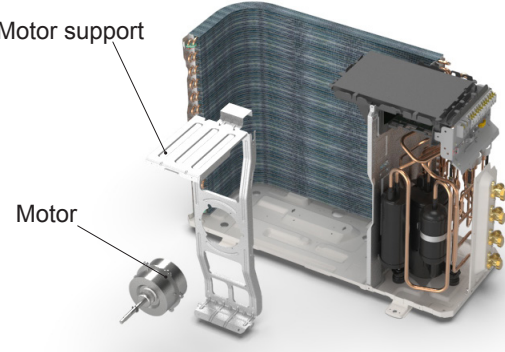
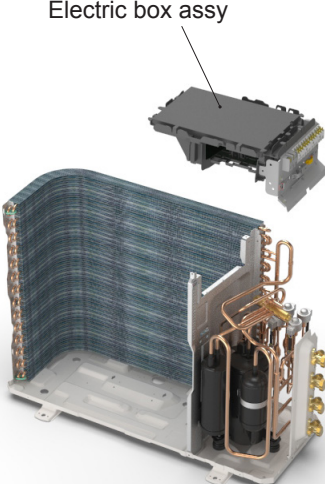
Step	Procedure
<b>10. Remove axial flow blade</b>	 <p>Remove the nut on the blade and then remove the axial flow blade.</p>
<b>11. Remove motor and motor support</b>	 <p>Remove the 4 tapping screws fixing the motor and disconnect the leading wire insert of the motor. Then remove the motor. Remove the 2 tapping screws fixing the motor support and chassis, and then lift the motor support to remove it.</p>
<b>12. Remove electric box assy</b>	 <p>Remove the screws fixing the electric box assy and the middle isolation sheet, loosen the wire bundle, unplug the wiring terminals, and then lift the electric box assy to remove it.</p>

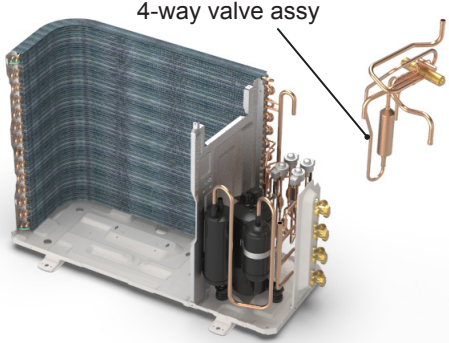
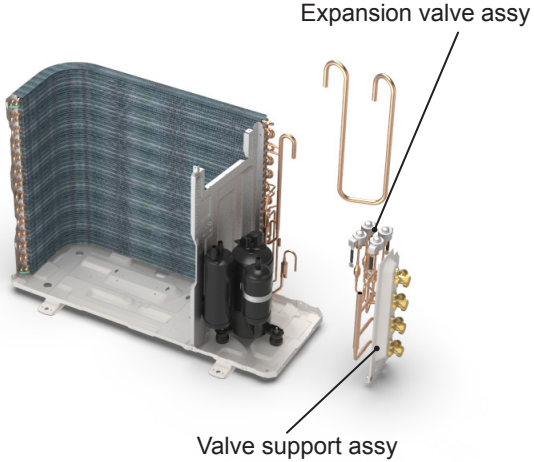
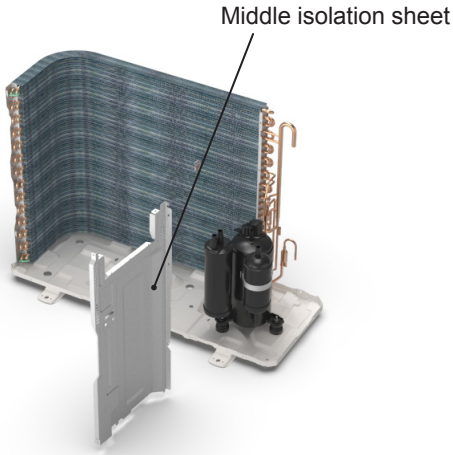

# 11. Removal Procedure

Step	Procedure
<b>13. Remove 4-way valve assy</b>	<p>Remove screws fixing the electricbox; loosen the wire bundle; pull out the wiring terminals and then pull electric box upwards to remove it.</p> 
<b>14. Remove valve support sub-assy and expansion valve assy</b>	<p>Remove the screw connecting the valve support and the chassis, and then remove the valve support assy. Unsolder the welding joint connecting the electronic expansion valve assy with the cut-off valve and the condenser connection pipe, and then remove the expansion valve assy.</p> 
<b>15. Remove middle isolation sheet</b>	<p>Remove the screws connecting the middle isolation sheet with the chassis assy and the condenser assy, and then remove the middle isolation sheet.</p> 

# 11. Removal Procedure

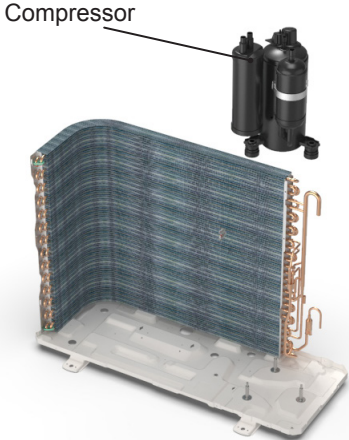
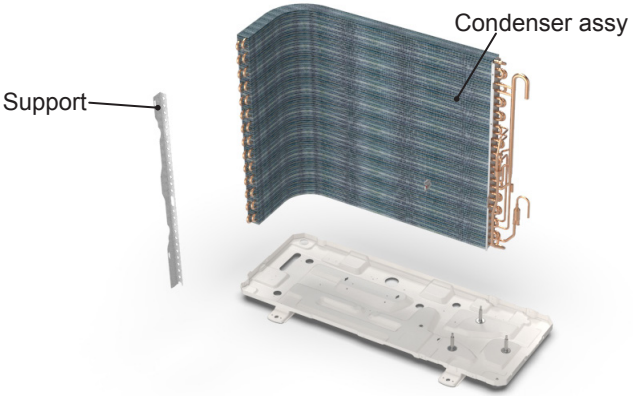
Step	Procedure
<b>16. Remove compressor</b>	<p>Remove the 3 foot nuts fixing the compressor and then remove the compressor.</p> 
<b>17. Remove condenser assy</b>	<p>Remove the screws fixing the condenser support and then remove the condenser support. Remove the screws connecting the condenser support and the chassis assy, and then remove the condenser assy.</p> 



# 11. Removal Procedure



CHML-U36RK4-NG  
CHML-U42RK5-NG



**Warning:** Be sure to wait for a minimum of 20 minutes after turning off all power supplies and discharge the refrigerant completely before removal.

Step	Procedure
<b>1. Before disassembly</b>	 <p>Complete axonometric drawing.</p>
<b>2. Remove valve cover</b>	 <p>Remove the connection screw fixing the valve cover and then remove the valve cover.</p> <p>valve cover</p>
<b>3. Remove handle</b>	 <p>Remove the connection screws fixing the handle and the right side plate, and then remove the handle.</p> <p>Handle</p>

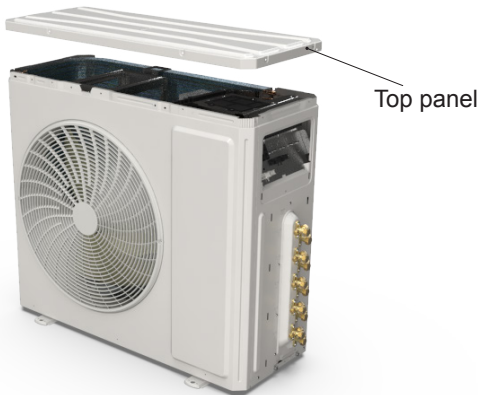
# 11. Removal Procedure

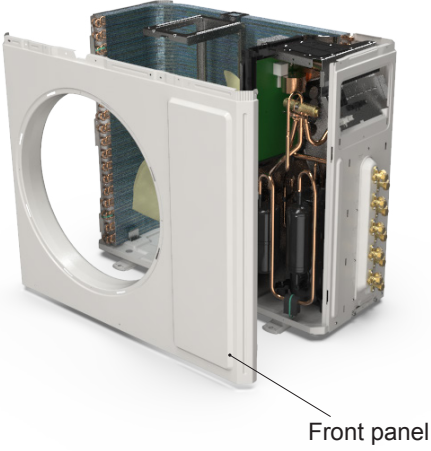
Step	Procedure
<b>4. Remove top panel</b>	<p>Remove the connection screws connecting the top panel and the front panel, and then remove the top panel.</p> 
<b>5. Remove front grille</b>	<p>Remove the connection screws connecting the front grille and the front panel, and then loosen the clasp to remove the front grille.</p> 
<b>6. Remove front panel</b>	<p>Remove the screws connecting the front panel and then remove the front panel.</p> 

# 11. Removal Procedure

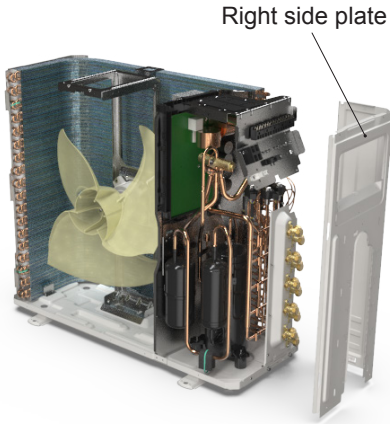
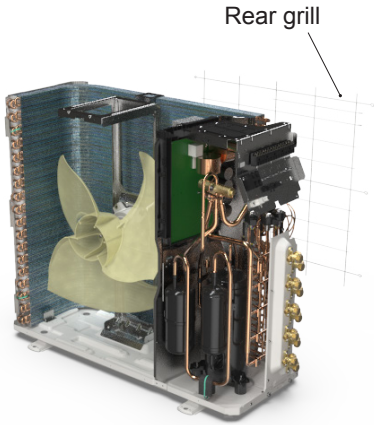
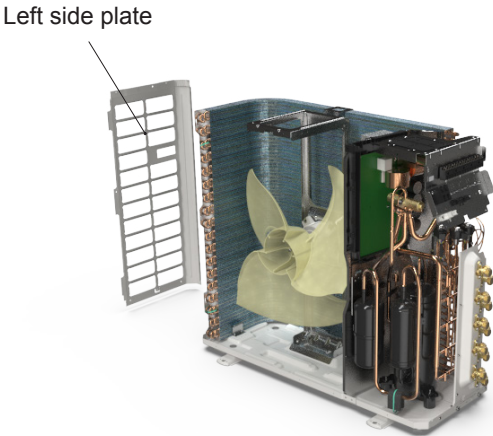
Step	Procedure
<b>7. Remove right side plate</b>	<p>Remove the screws connecting the right side plate with the chassis and the valve support. Then remove the right side plate.</p> 
<b>8. Remove rear grill</b>	<p>Remove the screws connecting the rear grill and left side plate, and then remove the rear grill.</p> 
<b>9. Remove left side plate</b>	<p>Remove the screws fixing the left side plate with the chassis and the condenser support, and then remove the left side plate.</p> 

# 11. Removal Procedure

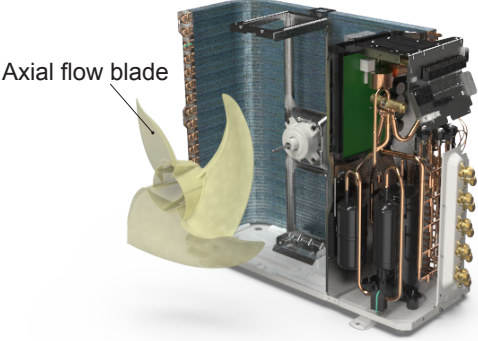
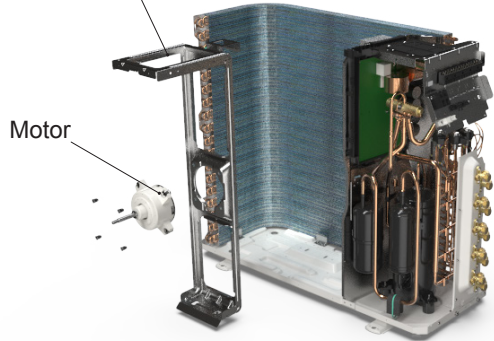
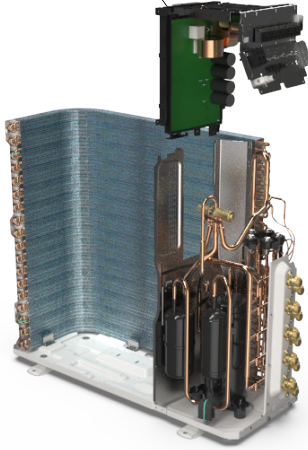
Step	Procedure
<b>10. Remove axial flow blade</b>	<p>Remove the nut on the blade and then remove the axial flow blade.</p>  <p>Axial flow blade</p>
<b>11. Remove motor and motor support</b>	<p>Remove the 4 tapping screws fixing the motor and disconnect the leading wire insert of the motor. Then remove the motor. Remove the 2 tapping screws fixing the motor support and chassis, and then lift the motor support to remove it.</p>  <p>Motor support</p> <p>Motor</p>
<b>12. Remove electric box assy</b>	<p>Remove the screws fixing the electric box assy and the middle isolation sheet, loosen the wire bundle, unplug the wiring terminals, and then lift the electric box assy to remove it.</p>  <p>Electric box assy</p>

# 11. Removal Procedure

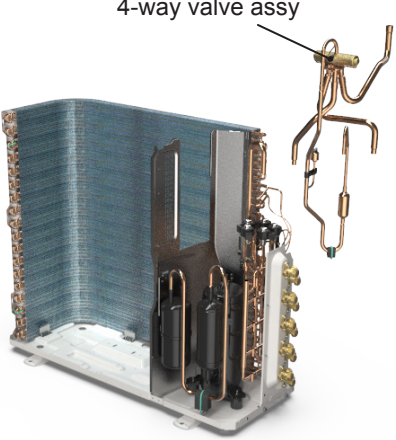
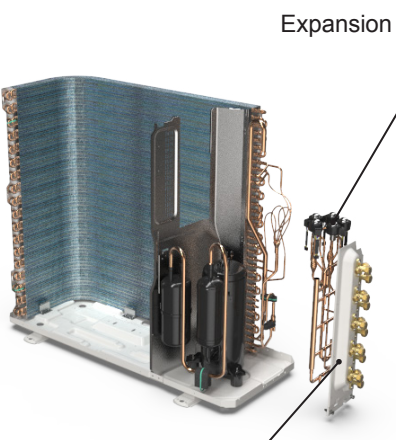
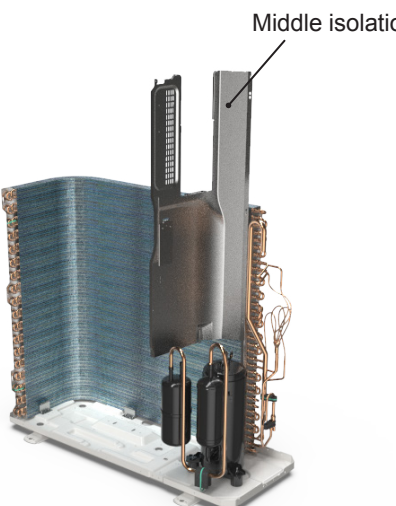
Step	Procedure	
<b>13. Remove 4-way valve assy</b>	Remove screws fixing the electricbox; loosen the wire bundle; pull out the wiring terminals and then pull electric box upwards to remove it.	 <p>A 3D cutaway diagram of the unit's internal components. A label '4-way valve assy' points to a complex copper piping assembly with four ports, which is being lifted away from the main unit. The unit's internal structure, including the condenser coils and other components, is visible in the background.</p>
<b>14. Remove valve support sub-assy and expansion valve assy</b>	Remove the screw connecting the valve support and the chassis, and then remove the valve support assy. Unsolder the welding joint connecting the electronic expansion valve assy with the cut-off valve and the condenser connection pipe, and then remove the expansion valve assy.	 <p>A 3D cutaway diagram of the unit's internal components. Two labels point to specific parts: 'Expansion valve assy' points to a small assembly on the right, and 'Valve support assy' points to a larger assembly below it. The diagram shows the internal layout of the unit, including the condenser coils and other components.</p>
<b>15. Remove middle isolation sheet</b>	Remove the screws connecting the middle isolation sheet with the chassis assy and the condenser assy, and then remove the middle isolation sheet.	 <p>A 3D cutaway diagram of the unit's internal components. A label 'Middle isolation sheet' points to a vertical metal plate that is being removed from the unit. The diagram shows the internal layout of the unit, including the condenser coils and other components.</p>

# 11. Removal Procedure

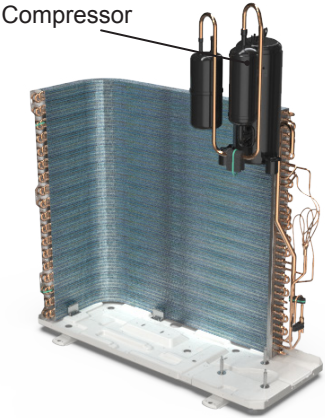
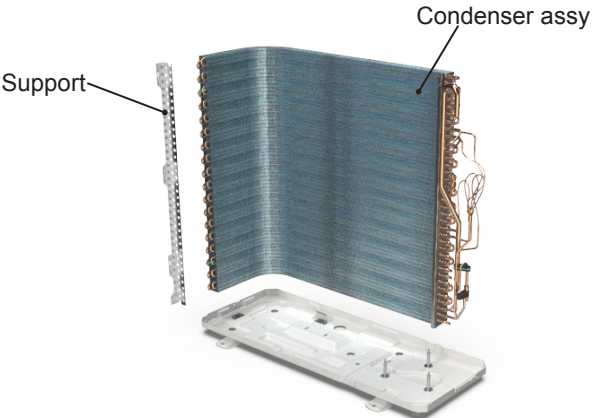
Step	Procedure
<b>16. Remove compressor</b>	 <p>Remove the 3 foot nuts fixing the compressor and then remove the compressor.</p>
<b>17. Remove condenser assy</b>	 <p>Remove the screws fixing the condenser support and then remove the condenser support. Remove the screws connecting the condenser support and the chassis assy, and then remove the condenser assy.</p>

# Appendix

## Appendix 1: Reference Sheet of Celsius and Fahrenheit

Conversion formula for Fahrenheit degree and Celsius degree:  $T_f = T_c \times 1.8 + 32$

### Set temperature

Fahrenheit display temperature (°F)	Fahrenheit (°F)	Celsius (°C)	Fahrenheit display temperature (°F)	Fahrenheit (°F)	Celsius (°C)	Fahrenheit display temperature (°F)	Fahrenheit (°F)	Celsius (°C)
61	60.8	16	69/70	69.8	21	78/79	78.8	26
62/63	62.6	17	71/72	71.6	22	80/81	80.6	27
64/65	64.4	18	73/74	73.4	23	82/83	82.4	28
66/67	66.2	19	75/76	75.2	24	84/85	84.2	29
68	68	20	77	77	25	86	86	30

### Ambient temperature

Fahrenheit display temperature (°F)	Fahrenheit (°F)	Celsius (°C)	Fahrenheit display temperature (°F)	Fahrenheit (°F)	Celsius (°C)	Fahrenheit display temperature (°F)	Fahrenheit (°F)	Celsius (°C)
32/33	32	0	55/56	55.4	13	79/80	78.8	26
34/35	33.8	1	57/58	57.2	14	81	80.6	27
36	35.6	2	59/60	59	15	82/83	82.4	28
37/38	37.4	3	61/62	60.8	16	84/85	84.2	29
39/40	39.2	4	63	62.6	17	86/87	86	30
41/42	41	5	64/65	64.4	18	88/89	87.8	31
43/44	42.8	6	66/67	66.2	19	90	89.6	32
45	44.6	7	68/69	68	20	91/92	91.4	33
46/47	46.4	8	70/71	69.8	21	93/94	93.2	34
48/49	48.2	9	72	71.6	22	95/96	95	35
50/51	50	10	73/74	73.4	23	97/98	96.8	36
52/53	51.8	11	75/76	75.2	24	99	98.6	37
54	53.6	12	77/78	77	25			



# Appendix

## Appendix 2: Pipe Expanding Method

### ⚠ Note:

Improper pipe expanding is the main cause of refrigerant leakage. Please expand the pipe according to the following steps:

#### A: Cut the pipe

- Confirm the pipe length according to the distance of indoor unit and outdoor unit.
- Cut the required pipe with pipe cutter.

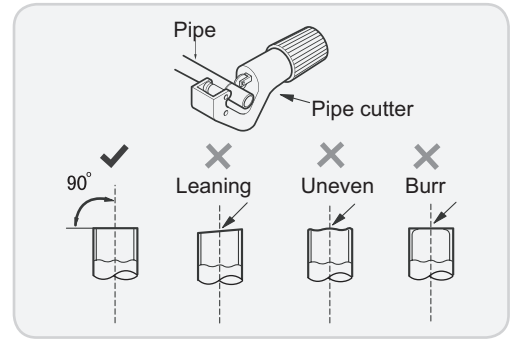

#### B: Remove the burrs

- Remove the burrs with shaper and prevent the burrs from getting into the pipe.

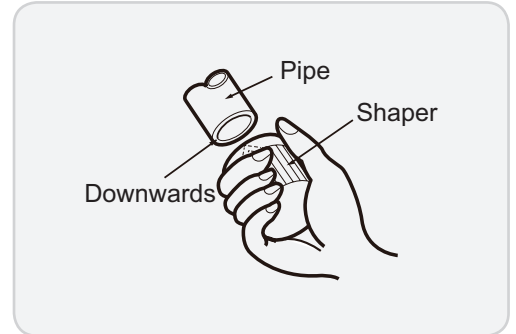

#### C: Put on suitable insulating pipe.

#### D: Put on the union nut

- Remove the union nut on the indoor connection pipe and outdoor valve; install the union nut on the pipe.

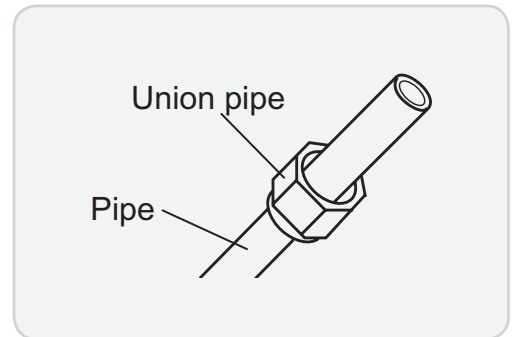

#### E: Expand the port

- Expand the port with expander.

### ⚠ Note:

- "A" is different according to the diameter, please refer to the sheet below:

Outer diameter(mm)	A(mm)	
	Max	Min
Φ6 - 6.35 (1/4")	1.3	0.7
Φ9 - Φ9.52 (3/8")	1.6	1.0
Φ12 - 12.70 (1/2")	1.8	1.0
Φ16 - 15.88 (5/8")	2.4	2.2

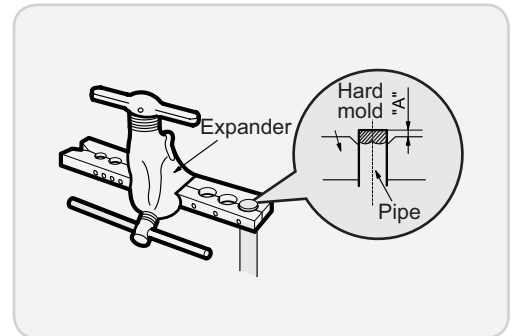

#### F: Inspection

- Check the quality of expanding port. If there is any blemish, expand the port again according to the steps above.

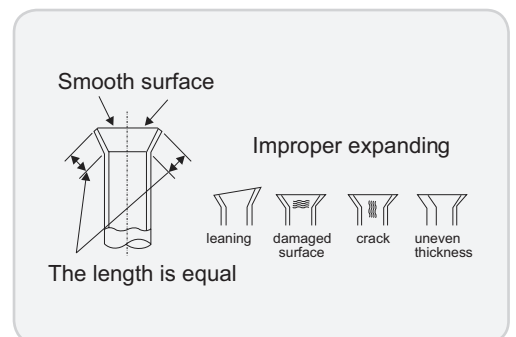



# Appendix

## Appendix 3: List of Resistance for Temperature Sensor

### Resistance Table of Ambient Temperature Sensor for Indoor and Outdoor Units(15K)

Temp(°C)	Resistance(kΩ)	Temp(°C)	Resistance(kΩ)	Temp(°C)	Resistance(kΩ)	Temp(°C)	Resistance(kΩ)
-19	138.1	20	18.75	59	3.848	98	1.071
-18	128.6	21	17.93	60	3.711	99	1.039
-17	121.6	22	17.14	61	3.579	100	1.009
-16	115	23	16.39	62	3.454	101	0.98
-15	108.7	24	15.68	63	3.333	102	0.952
-14	102.9	25	15	64	3.217	103	0.925
-13	97.4	26	14.36	65	3.105	104	0.898
-12	92.22	27	13.74	66	2.998	105	0.873
-11	87.35	28	13.16	67	2.896	106	0.848
-10	82.75	29	12.6	68	2.797	107	0.825
-9	78.43	30	12.07	69	2.702	108	0.802
-8	74.35	31	11.57	70	2.611	109	0.779
-7	70.5	32	11.09	71	2.523	110	0.758
-6	66.88	33	10.63	72	2.439	111	0.737
-5	63.46	34	10.2	73	2.358	112	0.717
-4	60.23	35	9.779	74	2.28	113	0.697
-3	57.18	36	9.382	75	2.206	114	0.678
-2	54.31	37	9.003	76	2.133	115	0.66
-1	51.59	38	8.642	77	2.064	116	0.642
0	49.02	39	8.297	78	1.997	117	0.625
1	46.6	40	7.967	79	1.933	118	0.608
2	44.31	41	7.653	80	1.871	119	0.592
3	42.14	42	7.352	81	1.811	120	0.577
4	40.09	43	7.065	82	1.754	121	0.561
5	38.15	44	6.791	83	1.699	122	0.547
6	36.32	45	6.529	84	1.645	123	0.532
7	34.58	46	6.278	85	1.594	124	0.519
8	32.94	47	6.038	86	1.544	125	0.505
9	31.38	48	5.809	87	1.497	126	0.492
10	29.9	49	5.589	88	1.451	127	0.48
11	28.51	50	5.379	89	1.408	128	0.467
12	27.18	51	5.197	90	1.363	129	0.456
13	25.92	52	4.986	91	1.322	130	0.444
14	24.73	53	4.802	92	1.282	131	0.433
15	23.6	54	4.625	93	1.244	132	0.422
16	22.53	55	4.456	94	1.207	133	0.412
17	21.51	56	4.294	95	1.171	134	0.401
18	20.54	57	4.139	96	1.136	135	0.391
19	19.63	58	3.99	97	1.103	136	0.382

# Appendix

Resistance Table of Tube Temperature Sensors for Indoor and Outdoor (20K)

Temp(°C)	Resistance(kΩ)	Temp(°C)	Resistance(kΩ)	Temp(°C)	Resistance(kΩ)	Temp(°C)	Resistance(kΩ)
-19	181.4	20	25.01	59	5.13	98	1.427
-18	171.4	21	23.9	60	4.948	99	1.386
-17	162.1	22	22.85	61	4.773	100	1.346
-16	153.3	23	21.85	62	4.605	101	1.307
-15	145	24	20.9	63	4.443	102	1.269
-14	137.2	25	20	64	4.289	103	1.233
-13	129.9	26	19.14	65	4.14	104	1.198
-12	123	27	18.13	66	3.998	105	1.164
-11	116.5	28	17.55	67	3.861	106	1.131
-10	110.3	29	16.8	68	3.729	107	1.099
-9	104.6	30	16.1	69	3.603	108	1.069
-8	99.13	31	15.43	70	3.481	109	1.039
-7	94	32	14.79	71	3.364	110	1.01
-6	89.17	33	14.18	72	3.252	111	0.983
-5	84.61	34	13.59	73	3.144	112	0.956
-4	80.31	35	13.04	74	3.04	113	0.93
-3	76.24	36	12.51	75	2.94	114	0.904
-2	72.41	37	12	76	2.844	115	0.88
-1	68.79	38	11.52	77	2.752	116	0.856
0	65.37	39	11.06	78	2.663	117	0.833
1	62.13	40	10.62	79	2.577	118	0.811
2	59.08	41	10.2	80	2.495	119	0.77
3	56.19	42	9.803	81	2.415	120	0.769
4	53.46	43	9.42	82	2.339	121	0.746
5	50.87	44	9.054	83	2.265	122	0.729
6	48.42	45	8.705	84	2.194	123	0.71
7	46.11	46	8.37	85	2.125	124	0.692
8	43.92	47	8.051	86	2.059	125	0.674
9	41.84	48	7.745	87	1.996	126	0.658
10	39.87	49	7.453	88	1.934	127	0.64
11	38.01	50	7.173	89	1.875	128	0.623
12	36.24	51	6.905	90	1.818	129	0.607
13	34.57	52	6.648	91	1.736	130	0.592
14	32.98	53	6.403	92	1.71	131	0.577
15	31.47	54	6.167	93	1.658	132	0.563
16	30.04	55	5.942	94	1.609	133	0.549
17	28.68	56	5.726	95	1.561	134	0.535
18	27.39	57	5.519	96	1.515	135	0.521
19	26.17	58	5.32	97	1.47	136	0.509

# Appendix

Resistance Table of Discharge Temperature Sensor for Outdoor(50K)

Temp(°C)	Resistance(kΩ)	Temp(°C)	Resistance(kΩ)	Temp(°C)	Resistance(kΩ)	Temp(°C)	Resistance(kΩ)
-29	853.5	10	98	49	18.34	88	4.75
-28	799.8	11	93.42	50	17.65	89	4.61
-27	750	12	89.07	51	16.99	90	4.47
-26	703.8	13	84.95	52	16.36	91	4.33
-25	660.8	14	81.05	53	15.75	92	4.20
-24	620.8	15	77.35	54	15.17	93	4.08
-23	580.6	16	73.83	55	14.62	94	3.96
-22	548.9	17	70.5	56	14.09	95	3.84
-21	516.6	18	67.34	57	13.58	96	3.73
-20	486.5	19	64.33	58	13.09	97	3.62
-19	458.3	20	61.48	59	12.62	98	3.51
-18	432	21	58.77	60	12.17	99	3.41
-17	407.4	22	56.19	61	11.74	100	3.32
-16	384.5	23	53.74	62	11.32	101	3.22
-15	362.9	24	51.41	63	10.93	102	3.13
-14	342.8	25	49.19	64	10.54	103	3.04
-13	323.9	26	47.08	65	10.18	104	2.96
-12	306.2	27	45.07	66	9.83	105	2.87
-11	289.6	28	43.16	67	9.49	106	2.79
-10	274	29	41.34	68	9.17	107	2.72
-9	259.3	30	39.61	69	8.85	108	2.64
-8	245.6	31	37.96	70	8.56	109	2.57
-7	232.6	32	36.38	71	8.27	110	2.50
-6	220.5	33	34.88	72	7.99	111	2.43
-5	209	34	33.45	73	7.73	112	2.37
-4	198.3	35	32.09	74	7.47	113	2.30
-3	199.1	36	30.79	75	7.22	114	2.24
-2	178.5	37	29.54	76	7.00	115	2.18
-1	169.5	38	28.36	77	6.76	116	2.12
0	161	39	27.23	78	6.54	117	2.07
1	153	40	26.15	79	6.33	118	2.02
2	145.4	41	25.11	80	6.13	119	1.96
3	138.3	42	24.13	81	5.93	120	1.91
4	131.5	43	23.19	82	5.75	121	1.86
5	125.1	44	22.29	83	5.57	122	1.82
6	119.1	45	21.43	84	5.39	123	1.77
7	113.4	46	20.6	85	5.22	124	1.73
8	108	47	19.81	86	5.06	125	1.68
9	102.8	48	19.06	87	4.90	126	1.64

